

1. FRAME & MISCELLANEOUS COVER COMPONENTS  
 頭部外装関係

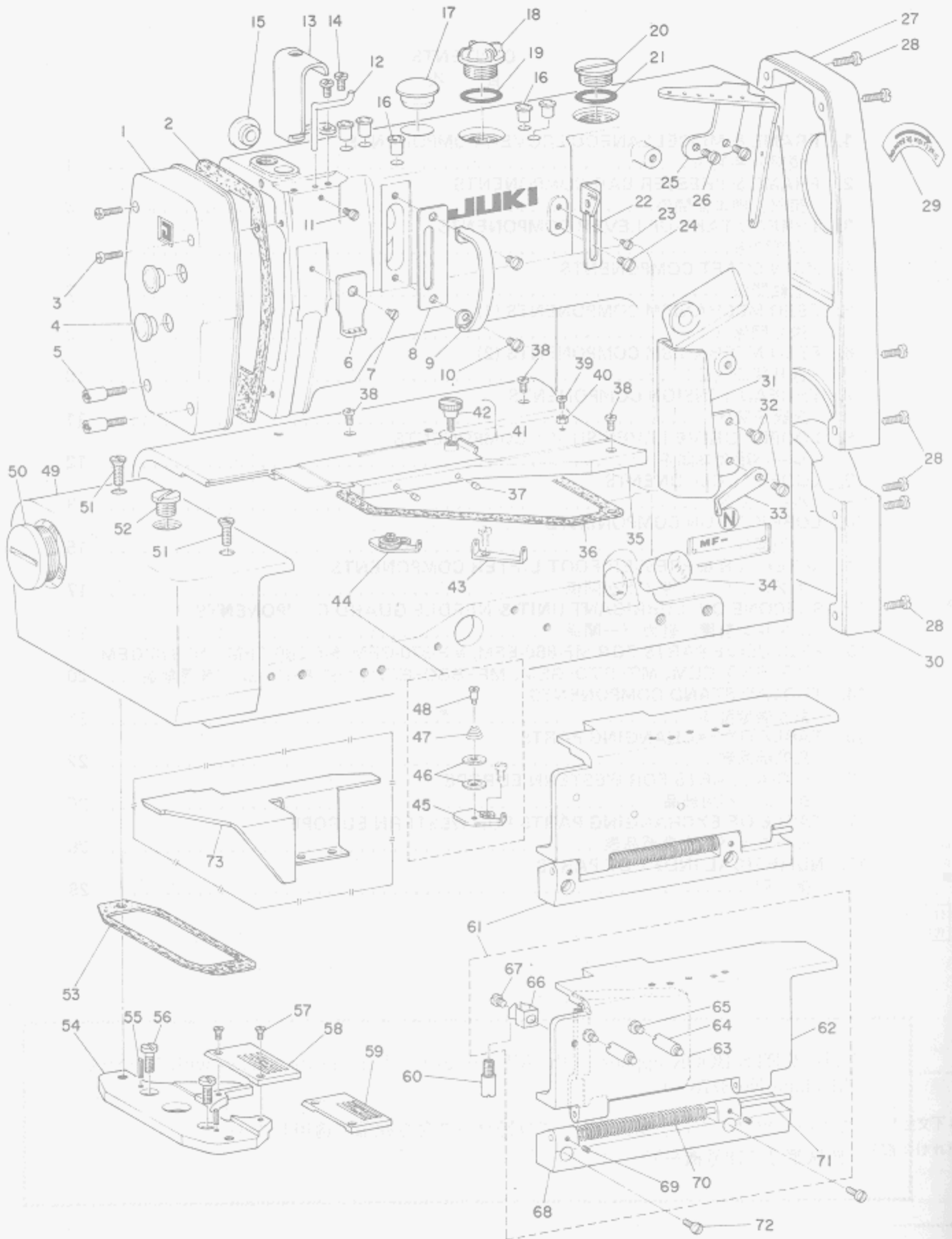

Ref. No.	Note 注記	Part No. 品番	Description	E. C. 変更年月	品名	Amt. Req. 数量
1		B1106-850-CC0-B	FACE PLATE		フェイス	1
2		B1107-850-CC0-A	FACE PLATE GASKET		フェイス パッキン	1
3		SS-7111410-SP	SCREW 11/64-40 L=14		メスヒラネジ 11/64-40 L=14	2
4		TA-125C406-RO	RUBBER PLUG	A.12/79	トメピン D=12.5 L=4	2
5		B1143-850-CC0	NEEDLE GUARD SET SCREW		ハリカハ 9/64-40	2
6		B1178-850-CC0	THREAD GUIDE		ハリトアソナイ	1
7		SS-209C550-TP	SCREW 9/64-40 L=5		メスヒラネジ 9/64-40 L=3.2	1
8		B1179-850-CC0	AUXILIARY THREAD TAKE-UP COVER BASE		ネジヨチンピン カハ 9/64-40	1
9		B1180-850-CC0	AUXILIARY THREAD TAKE-UP COVER		ネジヨチンピン カハ	1
10		SS-711C740-TP	SCREW 11/64-40 L=7		メスヒラネジ 11/64-40 L=7	2
11		SS-709C910-SP	SCREW 9/64-40 L= 8.5		メスヒラネジ 9/64-40 L=8.5	1
12		B1176-850-CC0	THREAD GUARD		イトウケ	1
13		B1177-850-CC0	THREAD TAKE-UP LEVER COVER		チンピンカハ	1
14		SS-711C740-TP	SCREW 11/64-40 L=7		メスヒラネジ 11/64-40 L=7	2
15		TA-125C406-RO	RUBBER PLUG	A.12/79	トメピン D=12.5 L=4	1
16		TA-075C704-RO	RUBBER PLUG	A.12/79	トメピン	5
17		TA-210C904-RO	RUBBER PLUG	A.12/79	トメピン	1
18		B1181-850-CC0	OIL SIGHT WINDOW	D.03/80	B3530-555-CC0	-
19		B3530-555-CC0	OIL SIGHT WINDOW	A.03/80	アブラマ	1
19		RO-2201801-CC	RUBBER RING	D.03/80	RO-1952401-00	-
20		RO-1952401-CC	RUBBER RING	A.03/80	オリック	1
21		B1140-352-CC0	PLUG SCREW		ワタ オヤネジ	1
22		RO-2201801-CC	RUBBER RING		オリック	1
23		B1131-850-CC0-C	TAKE-UP THREAD GUIDE		チンピン イトアソナイ	1
24		SS-609C510-SP	SCREW 9/64-40 L=5		ヒラネジ 9/64-40 L=5	1
25		SS-711C840-SP	SCREW 11/64-40 L=7.8		メスヒラネジ 11/64-40 L=7.8	1
26		B1125-850-CC0	THREAD GUIDE		9/64 イトアソナイ	1
27		SS-711C840-SP	SCREW 11/64-40 L=7.8		メスヒラネジ 11/64-40 L=7.8	2
28		B1138-850-CC0	BELT COVER A		ベルトカハ A	1
29		SS-7111120-SP	SCREW 11/64-40 L=10.5	M.02/79	メスヒラネジ 11/64-40 L=10.5	7
30		B1153-850-CC0	ROTATING DIRECTION INDICATING LABEL		カイデン ショウカ	1
31		B1139-850-CC0	BELT COVER B		ベルトカハ B	1
32		B1129-850-CC0	LOOPER THREAD COVER		ループ イトカハ	1
33		SS-711C740-TP	SCREW 11/64-40 L=7		メスヒラネジ 11/64-40 L=7	2
34		B1128-850-CC0	LOOPER THREAD GUIDE		シフトアソナイ	1
35		B3506-850-CC0	OIL SIGHT WINDOW A		アブラ ノゾキマ A	1
36		B1112-850-CC0-A	CLOTH PLATE		ヌメ	1
37		B1113-850-CC0	CLOTH PLATE GASKET		ヌメ	1
38		B1115-850-CC0	RUBBER PLUG		ヌメ	2
39		SS-7111120-SP	SCREW 11/64-40 L=10.5		メスヒラネジ 11/64-40 L=10.5	3
40		SS-711C710-SP	SCREW 11/64-40 L=7	D.07/81	メスヒラネジ 11/64-40 L=7	-
41		NS-611C310-SP	NUT 11/64-40	D.07/81	ワタ	-
42		B1114-850-CA0	CLOTH PLATE SIDE COVER ASM.		ヌメ	1
43		B2549-372-CC0	CLAMP SCREW A		ヒラネジ トメネジ A	(1)
44		B1162-850-CC0	LOOPER THREAD GUIDE A		シフトアソナイ A	1
45		B1163-850-CA0	LOOPER THREAD GUIDE B ASM.		シフトアソナイ B	1
46		B1163-850-CC0	LOOPER THREAD GUIDE B		シフトアソナイ B	(1)
47		E3148-123-CC0	TENSION DISC		イトアソナイ	(2)
48		B3149-123-CC0	CHAIN LOOPER THREAD TENSION SPRING		イトアソナイ	(1)
49		SD-C38C551-SL	HINGE SCREW D= 3.80 H= 5.5		ダンネジ D=3.8 H=5.5	(1)
50		B1123-850-CC0	BED COVER, LEFT		ベット ヒラネジ	1
51		B1154-850-CC0	HOLE COVER SCREW		ガット	1
52		SS-2661310-TP	SCREW 1/4-40 L=13.2		メスヒラネジ 1/4-40 L=13.2	2
53		B1139-C19-CC0	OIL RESERVOIR PLUG SCREW		アブラマ	1
54		B1124-850-CC0	GASKET		ヒラネジ	1
55		B1108-850-CC0	THROAT PLATE INSTALLING PLATE		ハリイ	1
56		PS-040C182-K0	SPRING PIN 4.CX18		スプリングピン 4.CX18	2
57		SS-7151210-SP	SCREW 15/64-28 L=12		メスヒラネジ 15/64-28 L=12	2
58		SS-209C820-TP	SCREW 9/64-40 L=8		メスヒラネジ 9/64-40 L=8	2
59	001	R4254-FOE-GCB	THROAT PLATE (EGE)		ハリイ	1
60	002	R4354-FOG-GGB	THROAT PLATE (GGB)		ハリイ	1
61		B1120-372-CC0	SCREW STUD		ストッド	1
62		B1116-850-CAB	LOOPER COVER ASM. A		ループカハ A	1
63		B1116-850-CC0-B	LOOPER COVER A		ループカハ A	(1)
64		B3540-850-CC0-A	LOOPER COVER OIL SHIELD		ループカハ	(1)
65		B3549-850-CC0	LOOPER COVER OIL SHIELD STUD		ループカハ	(2)
66		SS-711C510-SP	SCREW 11/64-40 L=5		メスヒラネジ 11/64-40 L=5	(2)
67		B1111-372-CC0	SIDE COVER SPRING	A.05/79	ソクメンカハ	(1)
68		SS-711C410-SP	SCREW 11/64-40 L=4		メスヒラネジ 11/64-40 L=4	(1)
69		B1118-850-CC0	COVER HINGE		カハ	(1)
70		SS-809C410-SP	SCREW 9/64-40 L= 3.5		トメネジ 9/64-40 L=3.5	(2)
71		B1120-850-CC0	COVER HINGE SPRING		カハ	(1)
72		B1119-850-CC0	COVER HINGE RCD		カハ	(1)
73	028	B1121-890-CC0	LOOPER AUXILIARY COVER	A.05/83	ループカハ	1

Note (注記) ◇01.....For MF-860-EDM, MF-880-EDM MF-860-EDM, MF-880-EDM用  
◇02.....For MF-870-GDM, MF-890-GDM MF-870-GDM, MF-890-GDM用  
◇28.....For Special order part 特別注文部品

1. FRAME & MISCELLANEOUS COVER COMPONENTS

2. FRAME & PRESSER BAR COMPONENTS

頭部、押工棒関係

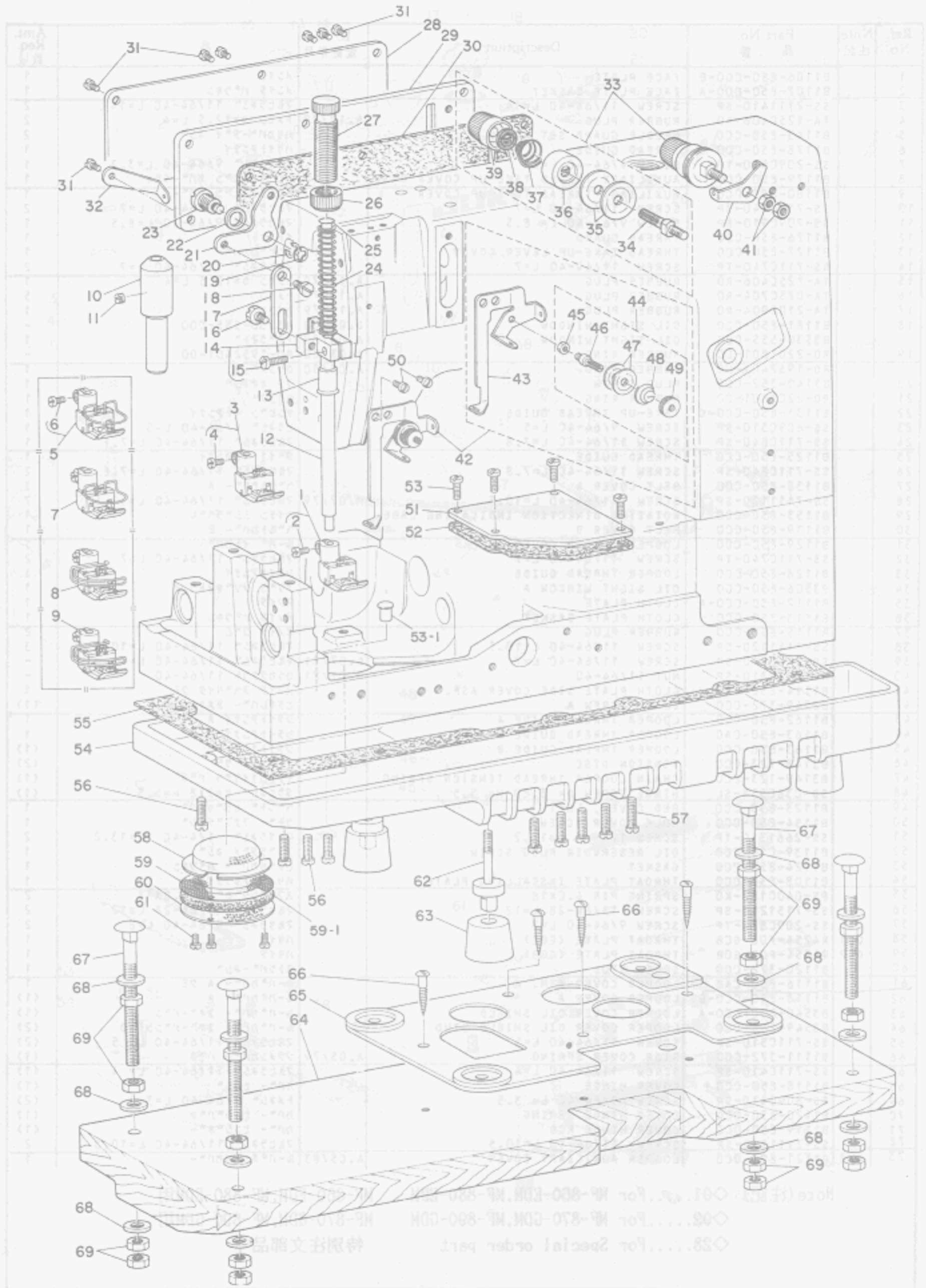

3. THREAD TAKE UP LEVER COMPONENTS  
糸調り部

Ref. No.	Note	Part No.	Description	E. C. 変更年月	品名	Amt. Req. 数量
1	◇01	R5202-F0E-1AD	PRESSER FOOT ASM. (ED)		オウエ (ED) クミ	1
2		SS-6090670-TP	SCREW 9/64-40 L=6		ヒラネシ* 9/64-40 L=6	(1)
3	◇02	R5302-F0G-1AD	PRESSER FOOT ASM. (GD)		オウエ (GD) クミ	1
4		SS-6090670-TP	SCREW 9/64-40 L=6		ヒラネシ* 9/64-40 L=6	(1)
5	◇03	R5202-F0E-0BD	PRESSER FOOT ASM. (ED)		オウエ (ED) クミ	1
6		SS-6090670-TP	SCREW 9/64-40 L=6		ヒラネシ* 9/64-40 L=6	(1)
7	◇04	R5302-F0G-0BD	PRESSER FOOT ASM. (GD)		オウエ (GD) クミ	1
8	◇05	R5202-F0E-1BD	PRESSER FOOT ASM. (ED)		オウエ (ED) クミ	1
9	◇06	R5302-F0G-1BD	PRESSER FOOT ASM. (GD)		オウエ (GD) クミ	1
10	◇07	B1503-850-000	PRESSER BAR BUSHING		オウエ* - メタル	1
11	◇07	SS-8150310-SP	SCREW 15/64-28 L=3.4		トメネシ* 15/64-28 L=3.4	1
12		B1501-850-000	PRESSER BAR		オウエ* -	1
13		B1511-850-000	PRESSER BAR CAP		オウエ* - キャップ	1
14		B1505-850-0A0	PRESSER BAR GUIDE BRACKET ASM.		オウエ* - 2*キ クミ	1
15		SS-7111310-TP	SCREW 11/64-40 L=12.8		マルヒラネシ* 11/64-40 L=12.8	(1)
16		SD-0630275-SP	HINGE SCREW D=6.35 H=2.7		タ*ンネシ* D=6.35 H=2.7	1
17		B1506-850-000	LIFTING LEVER		ヒキアケ*イタ	1
18		SD-0630272-SP	HINGE SCREW		タ*ンネシ*	1
19		B1523-226-000	SNAP RING		トメワ B	1
20		RE-0600000-K0	SNAP RING 6		Eカ*タ トメワ 6	1
21		B1507-850-000	LIFTING LEVER LINK		ヒキアケ*イタ リンク	1
22		B3431-581-000	LIFTING LEVER GASKET		ハ*ツキン	1
23		B1508-850-000	SCREW 3/8 L=14.5		ヒキアケ*イタ リンクシ*ク	1
24		B1505-227-000-A	PRESSER SPRING		オウエ チョ-セツバ*ネ	1
25		B1510-227-000	PRESSER GUIDE BAR		オウエ アンナイ* -	1
26		NS-2820850-SA	NUT 1/2-28	D.07/79	B1511-555-000	-
27		B1511-555-000	NUT 1/2-28	A.07/79	オウエチヨ-セツネシ* ナツト	1
28	◇07	B1509-227-000	PRESSER SPRING REGULATOR		オウエ チヨ-セツネシ*	1
29	◇08	B1110-860-000	SIDE COVER		マト*イタ	1
30		B1110-880-000	SIDE COVER		マト*イタ	1
31		B1111-880-000	SIDE COVER GASKET		マト*イタ ハ*ツキン	1
32	◇08	SS-7111120-SP	SCREW 11/64-40 L=10.5		マルヒラネシ* 11/64-40 L=10.5	7
33	◇08	B1128-850-000	LOOPER THREAD GUIDE		シタイトアンナイ	1
34	◇08	B3928-880-0A0	THREAD SPREADER TENSION ASM.		ス*レツタ* イトチヨ-シ クミ	1
35	◇08	B3126-012-000	TENSION DISC		ス*レツタ* - イトチヨ-シ* -	(1)
36	◇08	B3107-704-000	TENSION DISC PRESSER TUBE		イトチヨ-シ*ラ	(2)
37	◇08	B2017-372-000	TENSION SPRING NO.1		チヨ-シ*ラ オウエ	(1)
38	◇08	B3120-125-000	TENSION DISC STOPPER		タ*イ1 イトチヨ-シ*ハ*ネ	(1)
39	◇08	B3119-771-000	TENSION NUT		イトチヨ-シ*ラ カイヂント*メ	(1)
40	◇08	B3929-880-000	THREAD SPREADER TENSION EYELET		イトチヨ-シ*ラツト	(1)
41	◇08	NS-6150310-SP	NUT 15/64-28		ス*レツタ* - イトチヨ-シ* - アンナイ	1
42	◇08	B3932-880-0A0	THREAD GUIDE ASM.		6カクナツト 15/64-28	2
43	◇08	B3932-880-000	THREAD GUIDE		スレツト* カ*イト* クミ	1
44	◇08	B3150-880-0A0	SUPPLEMENTARY TENSION POST ASM		スレツト* カ*イト*	(1)
45	◇08	NS-6110310-SP	NUT 11/64-40		タ*イ2 イトチヨ-シ* - クミ	(1)
46	◇08	B3219-232-000	BOBBIN WINDER TENSION POST		6カクナツト 11/64-40	(1)
47	◇08	B3214-047-000	BOBBIN WINDER TENSION DISC		イト*キ イトチヨ-シ* -	(1)
48	◇08	B3168-555-H08	TENSION SPRING NO. 1		イトチヨ-シ* ラ	(2)
49	◇08	B3216-047-000	BOBBIN WINDER TENSION NUT		タ*イイチ イトチヨ-シ* ハ*ネ	(1)
50	◇08	SS-7110740-TP	SCREW 11/64-40 L=7		イトチヨ-シ* ナツト	(1)
51		B1158-850-000	BED COVER		マルヒラネシ* 11/64-40 L=7	2
52		B1159-850-000	BED COVER GASKET		ハ*ツト*フタ	1
53		SS-7111120-SP	SCREW 11/64-40 L=10.5		ハ*ツト フタハ*ツキン	1
53-1		TA-0750704-R0	RUBBER PLUG	A.12/79	マルヒラネシ* 11/64-40 L=10.5	4
54		B1104-850-000-A	BOTTOM PLATE		トメセン	1
55		B1105-850-000-A	BOTTOM PLATE GASKET		ソコイタ	1
56		SS-6151440-SP	SCREW 15/64-28 L=14		ソコイタハ*ツキン	1
57		SS-6151920-TP	SCREW 15/64-28 L=19.0		ヒラネシ* 15/64-28 L=14	4
58		B1173-850-000	FILTER SCREEN	D.05/81	ヒラネシ* 15/64-28 L=19	5
59		B1150-850-000-A	LINT FILTER SCREEN A	D.05/81	ロカモク	-
59-1		B1185-850-000	LINT FILTER SCREEN B	D.05/81	ロカモク A	-
60		B1170-850-000	LINT FILTER SCREEN PRESSER	D.05/81	ロカモク B	-
61		SS-6090650-SP	SCREW 9/64-40 L=6	D.05/81	ロカモク オウエ	-
62		B1151-850-000-A	RUBBER COLLAR STUD		ヒラネシ* 9/64-40 L=6	-
63		B1152-850-000	CUSHION RUBBER		ソコイタ ククコ*ムシ*ク	4
64		B8202-850-000	FRAME SUPPORT PLATE		ソコイタ ククコ*ム	4
65		B8203-850-000	BED SPACER		クケイタ	1
66		SK-3623200-SC	WOOD SCREW D=6.2 L=32		ハ*ツト* ククカ*ネ	1
67		B8205-850-000	BOLT		マルモクネシ* D=6.2 L=32	4
68		WP-1002036-SC	WASHER 10.0X21.0X2.0		クケイタ *トルト	4
69		NS-6240630-SN	NUT 3/8-18		ヒラツ*カ*ネ 10.0X21.0X2	12
					6カクナツト 3/8-18	16

Note. (注記) ◇01. . . . . For MF-860-EDM, MF-880-EDM  
 ◇02. . . . . For MF-870-GDM, MF-890-GDM  
 ◇03. . . . . Special order part for MF-860-EDM (With finger guard)  
 ◇04. . . . . Special order part for MF-870-GDM (With finger guard)  
 ◇05. . . . . Special order part for MF-880-EDM (With finger guard)  
 ◇06. . . . . Special order part for MF-890-GDM (With finger guard)  
 ◇07. . . . . For MF-860, MF-870  
 ◇08. . . . . For MF-880, MF-890





Ref. No.	Note 注記	Part No. 品番	Description	E. C. 変更年月	品名	Amt. Req. 数量
1		MC-380C006-S0	NEEDLE 38:00 #65 (UY128GAS)		ハリ UY128GAS 65	3
2		B1412-850-CB0	NEEDLE BAR TENSION BASE ASM.		ハリホキ- チヨ-シタ <sup>イ</sup> クミ	1
3		B1412-850-CA0	NEEDLE BAR TENSION BASE ASM.		チヨ-シタ <sup>イ</sup> クミ	(1)
4	*	SS-609C510-TP	SCREW 9/64-40 L= 5.0	D.07/84	SS-7090620-TP	-
		SS-709C620-TP	SCREW 9/64-40 L=6.1	A.07/84	マシヒラネ <sup>シ</sup> 9/64-40 L=6.1	(1)
5		B1413-850-CC0	NEEDLE BAR TENSION DISC		ハリホキ- チヨ-シタ <sup>イ</sup> マシ	(1)
6		B1131-521-CC0	THREAD PRESSER PLATE		ハリイト オサエ <sup>イ</sup>	(1)
7		B1136-850-CC0	TENSION SPRING B		ハリイト チヨ-シタ <sup>イ</sup> E	(1)
8		SD-C38C551-SL	HINGE SCREW D= 3.80 H= 5.5		タ <sup>ン</sup> ネ <sup>シ</sup> D=3.8 H=5.5	(1)
9		B1403-850-CC0	NEEDLE BAR BUSHING, LOWER		ハリホキ- シタ <sup>イ</sup> メ <sup>シ</sup>	1
10		SS-815C710-SP	SCREW 15/64-28 L=7		トメネ <sup>シ</sup> 15/64-28 L=7	2
11		B1401-860-C00-A	NEEDLE BAR		ハリホキ-	1
12		B1411-481-CE0	NEEDLE BAR CONNECTION ASM		ハリホキ-5 <sup>キ</sup> クミ	1
13		SS-609C670-TP	SCREW 9/64-40 L=6		ヒラネ <sup>シ</sup> 9/64-40 6=6	(1)
14		WP-036C516-SD	WASHER #3		ヒラサ <sup>カ</sup> カ <sup>ネ</sup> 3.6X5.2X0.5	(1)
15		CO-4000000-FO	OIL FELT	A.12/78	ロ <sup>ウ</sup> ト <sup>ク</sup> フェルト	(0.1)
16		B1402-850-CC0-A	NEEDLE BAR BUSHING, UPPER		ハリホキ-メ <sup>タル</sup>	1
17		B1405-850-CB0-A	NEEDLE BAR THREAD EYELET ASM.		ハリホキ-チ <sup>ン</sup> ヒ <sup>ン</sup> クミ	1
18		SS-609C670-TP	SCREW 9/64-40 L=6		ヒラネ <sup>シ</sup> 9/64-40 6=6	(1)
19		WP-036C516-SD	WASHER #3		ヒラサ <sup>カ</sup> カ <sup>ネ</sup> 3.6X5.2X0.5	(1)
20		B1182-850-CC0	RUBBER PLUG		チ <sup>ン</sup> ヒ <sup>ン</sup> シ <sup>ク</sup> コ <sup>ム</sup> ヒ <sup>ン</sup>	1
21		SS-709C530-SP	SCREW 9/64-40 L= 4.5		マシヒラネ <sup>シ</sup> 9/64-40 L=4.5	1
22		B1911-850-CC0	AUXILIARY THREAD TAKE-UP LEVER		ホ <sup>シ</sup> ヨ <sup>チ</sup> ン <sup>シ</sup> ク	1
23		B1910-850-CC0	THREAD TAKE-UP LEVER BASE		ホ <sup>シ</sup> ヨ <sup>チ</sup> ン <sup>シ</sup> ク <sup>イ</sup>	1
24		SS-611C710-TP	SCREW 11/64-40 L= 6.5		ヒラネ <sup>シ</sup> 11/64-40 L=6.5	1
25		B1912-850-CC0	OIL SEAL		マ <sup>メ</sup> メ <sup>タル</sup> オ <sup>イル</sup> シ <sup>ール</sup>	1
26		B19C6-850-CC0	BUSHING, FRONT		チ <sup>ン</sup> ヒ <sup>ン</sup> シ <sup>ク</sup> マ <sup>メ</sup> メ <sup>タル</sup>	1
27		SS-8151230-SP	SCREW 15/64-28 L=12		トメネ <sup>シ</sup> 15/64-28 L=12	2
28		CS-070C81A-SH	THRUST COLLAR ASM. D=7 W=E		ス <sup>ラ</sup> スト <sup>ラ</sup> D=7 W=E	2
29		SS-611C620-TP	SCREW 11/64-40 L= 5.5		ヒラネ <sup>シ</sup> 11/64-40 L=5.5	(2)
30		B19C4-850-CAC	LINK SHAFT BRACKET ASM.		ホ <sup>シ</sup> ヨ <sup>チ</sup> ン <sup>シ</sup> ク リ <sup>ン</sup> ク <sup>シ</sup> ク <sup>ラ</sup> ク <sup>ラ</sup> クミ	1
31		SS-6111010-TP	SCREW 11/64-40 L= 9.5	D.03/84	SS-7110910-TP	-
		SS-711C910-TP	SCREW 11/64-40 L= 8.5	A.03/84	マシヒラネ <sup>シ</sup> 11/64-40 L=8.5	(1)
32		B1905-850-CC0	THREAD TAKE-UP LEVER SHAFT		ホ <sup>シ</sup> ヨ <sup>チ</sup> ン <sup>シ</sup> ク	1
33		B1907-850-CC0	BUSHING, REAR		チ <sup>ン</sup> ヒ <sup>ン</sup> シ <sup>ク</sup> ク <sup>シ</sup> ロ <sup>メ</sup> シ <sup>ル</sup>	1
34		SS-709C910-SP	SCREW 9/64-40 L= 8.5		マシヒラネ <sup>シ</sup> 9/64-40 L=8.5	3
35		B1903-850-CC0	LINK THRUST		ホ <sup>シ</sup> ヨ <sup>チ</sup> ン <sup>シ</sup> ク リ <sup>ン</sup> ク ス <sup>ラ</sup> スト	1
36		B1902-850-CC0	THREAD TAKE-UP LEVER LINK		ホ <sup>シ</sup> ヨ <sup>チ</sup> ン <sup>シ</sup> ク リ <sup>ン</sup> ク	1
37		B1901-850-CAC	THREAD TAKE-UP LEVER CAM ASM.		ホ <sup>シ</sup> ヨ <sup>チ</sup> ン <sup>シ</sup> ク カ <sup>ム</sup> クミ	1
38		SS-8661030-SP	SCREW 1/4-40 L=10		トメネ <sup>シ</sup> 1/4-40 L=10	2
39		B1909-850-CC0	TIMING ADJUSTING SCREW		タイ <sup>ミ</sup> ン <sup>ク</sup> チヨ-ヒ-ネ <sup>シ</sup>	1
40		B1908-850-CC0	TIMING ADJUSTING THRUST		タイ <sup>ミ</sup> ン <sup>ク</sup> チヨ-ヒ-ス <sup>ラ</sup> スト	1
41		SS-8661030-SP	SCREW 1/4-40 L=10		トメネ <sup>シ</sup> 1/4-40 L=10	2
42	009	B1409-860-EA0	NEEDLE CLAMP ASM. E		ハリト <sup>メ</sup> E クミ	1
43	009	B1409-860-EC0	NEEDLE CLAMP E		ハリト <sup>メ</sup> E	(1)
44	009	SS-808C310-TP	SCREW 1/8-44 L=2.8		トメネ <sup>シ</sup> 1/8-44 L=2.8	(2)
45	009	B1410-860-FC0	THREAD GUIDE WIRE F		ハリト <sup>メ</sup> イ <sup>ト</sup> ア <sup>ン</sup> タイ F	(1)
46	009	SS-606C210-SP	SCREW 3/32-56 L= 1.9		ヒラネ <sup>シ</sup> 3/32-56 L=1.9	(1)
47	010	B1409-870-GA0	NEEDLE CLAMP ASM. G		ハリト <sup>メ</sup> G クミ	1
48	010	B1409-870-GC0	NEEDLE CLAMP G		ハリト <sup>メ</sup> G	(1)
49	010	SS-808C310-TP	SCREW 1/8-44 L=2.8		トメネ <sup>シ</sup> 1/8-44 L=2.8	(3)
50	010	B1410-860-HC0	THREAD GUIDE WIRE H		ハリト <sup>メ</sup> イ <sup>ト</sup> ア <sup>ン</sup> タイ H	(1)
51	010	SS-606C210-SP	SCREW 3/32-56 L= 1.9		ヒラネ <sup>シ</sup> 3/32-56 L=1.9	(1)
52	011	B1409-880-EA0	NEEDLE CLAMP ASM. E		ハリト <sup>メ</sup> E クミ	1
53	011	B1409-880-EC0	NEEDLE CLAMP E		ハリト <sup>メ</sup> E	(1)
54	011	SS-808C310-TP	SCREW 1/8-44 L=2.8		トメネ <sup>シ</sup> 1/8-44 L=2.8	(2)
55	011	B1410-860-FO0	THREAD GUIDE WIRE F		ハリト <sup>メ</sup> イ <sup>ト</sup> ア <sup>ン</sup> タイ F	(1)
56	011	B3933-880-CC0	SPREADER THREAD GUIDE		ス <sup>パ</sup> レ <sup>ツ</sup> ス <sup>ク</sup> - イ <sup>ト</sup> ア <sup>ン</sup> タイ	(1)
57	011	SS-606C410-TP	SCREW 3/32-56 L= 3.5		ヒラネ <sup>シ</sup> 3/32-56 L=3.5	(1)
58	011	SS-606C210-SP	SCREW 3/32-56 L= 1.9		ヒラネ <sup>シ</sup> 3/32-56 L=1.9	(1)
59	012	B1409-890-GA0	NEEDLE CLAMP ASM. G		ハリト <sup>メ</sup> G クミ	1
60	012	B1409-890-GC0	NEEDLE CLAMP G		ハリト <sup>メ</sup> G	(1)
61	012	SS-808C310-TP	SCREW 1/8-44 L=2.8		トメネ <sup>シ</sup> 1/8-44 L=2.8	(3)
62	012	B1410-860-HC0	THREAD GUIDE WIRE H		ハリト <sup>メ</sup> イ <sup>ト</sup> ア <sup>ン</sup> タイ H	(1)
63	012	B3933-880-CC0	SPREADER THREAD GUIDE		ス <sup>パ</sup> レ <sup>ツ</sup> ス <sup>ク</sup> - イ <sup>ト</sup> ア <sup>ン</sup> タイ	(1)
64	012	SS-606C410-TP	SCREW 3/32-56 L= 3.5		ヒラネ <sup>シ</sup> 3/32-56 L=3.5	(1)
65	012	SS-606C210-SP	SCREW 3/32-56 L= 1.9		ヒラネ <sup>シ</sup> 3/32-56 L=1.9	(1)

Note. (注記) ◇09. . . . . For MF-860-EDM, MF-860-EEM MF-860-EDM, MF-860-EEM#  
 ◇10. . . . . For MF-870-GDM, MF-870-GEM MF-870-GDM, MF-870-GEM#  
 ◇11. . . . . For MF-880-EDM, MF-880-EEM MF-880-EDM, MF-880-EEM#  
 ◇12. . . . . For MF-890-GDM, MF-890-GEM MF-890-GDM, MF-890-GEM#

# 4. MAIN SHAFT COMPONENTS 上軸関係

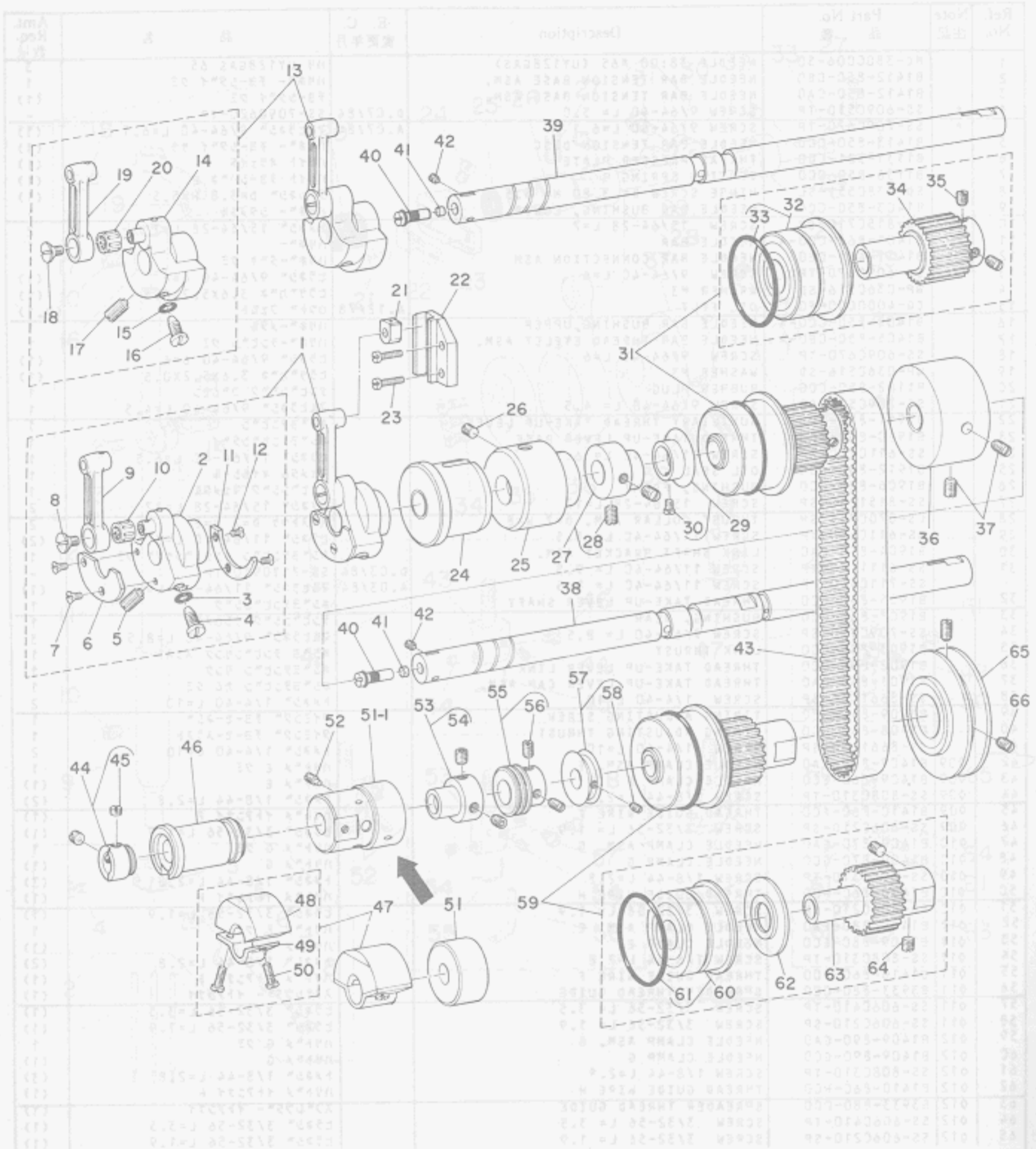

MF-850-DEM, MF-860-DEM  
 MF-870-DEM, MF-870-DEM  
 MF-880-DEM, MF-880-DEM  
 MF-890-DEM, MF-890-DEM

For MF-850-DEM, MF-860-DEM  
 For MF-870-DEM, MF-870-DEM  
 For MF-880-DEM, MF-880-DEM  
 For MF-890-DEM, MF-890-DEM

Note (1):  
 010  
 011  
 012

Ref. No.	Note 注記	Part No. 品番	Description	E. C. 変更年月	品名	Amt. Req. 数量
1	#08	B1206-880-0A0	COUNTERWEIGHT ASM.		ツリアイオモリ クミ	1
2	#08	B1206-880-0B0	COUNTERWEIGHT ASM.		ツリアイオモリ クミ	(1)
3		RO-0442401-00	RUBBER RING		オリック*	(1)
4		SS-7681750-TP	SCREW 9/32-28 L=16.5	D.03/84	SS-7681410-TP	-
		SS-7681410-TP	SCREW 9/32-28 L=13.5	A.03/84	マルヒラネシ*	(1)
5		SS-8681650-TP	SCREW 9/32-28 L=16		トメネシ* 9/32-28 L=16	(1)
6	#08	B1207-880-000	COUNTER BALANCE A		ツリアイ ハ*ランス A	(1)
7	#08	SS-2090620-SP	SCREW 9/64-40 L=5.5		マルウラネシ* 9/64-40 L=5.5	(2)
8		B1903-552-000	END SCREW LEFT		ヒタ*リネシ*	(1)
9		B1408-850-000	NEEDLE BAR CRANK ROD		ハリホ* - クラック*ツト*	(1)
10	#13	B1905-541-800	NEEDLE BEARING, B		テンヒ*ン ニート*ルハ*アリック*	(1)
11	#08	B1208-880-000	COUNTER BALANCE B		ツリアイ ハ*ランス B	(1)
12	#08	SS-2090710-SP	SCREW 9/64-40 L=7		マルウラネシ* 9/64-40 L=7	(2)
13	#07	B1206-860-0A0	COUNTERWEIGHT ASM.		ツリアイオモリ クミ	1
14	#07	B1206-860-0B0	COUNTERWEIGHT ASM.		ツリアイオモリ クミ	(1)
15		RO-0442401-00	RUBBER RING		オリック*	(1)
16		SS-7681750-TP	SCREW 9/32-28 L=16.5		マルヒラネシ* 9/32-28 L=16.5	(1)
17		SS-8681650-TP	SCREW 9/32-28 L=16		トメネシ* 9/32-28 L=16	(1)
18		B1903-552-000	END SCREW LEFT		ヒタ*リネシ*	(1)
19		B1408-850-000	NEEDLE BAR CRANK ROD		ハリホ* - クラック*ツト*	(1)
20	#13	B1905-541-800	NEEDLE BEARING, B		テンヒ*ン ニート*ルハ*アリック*	(1)
21		B1414-226-000	NEEDLE BAR CONNECTION SLIDE BLOCK		カクコ*マ	1
22		B1415-850-000	SLID BLOCK GUIDE		コロ アンガイタイ	1
23		SS-7111410-SP	SCREW 11/64-40 L=14		マルヒラネシ* 11/64-40 L=14	2
24		B1202-850-0A0	MAIN SHAFT BUSHING ASM.		ウウシ*ク マイタル クミ	1
25		B1203-850-000	MAIN SHAFT BUSHING, INTERMEDIATE		ウウシ*ク ナカメタル	1
26		SS-8150710-SP	SCREW 15/64-28 L=7		トメネシ* 15/64-28 L=7	1
27	#08	B3920-880-0A0	SPREADER PULL-OFF CAM ASM.		スワ*レツタ* - テンヒ*ン カム クミ	1
28	#08	SS-8660610-TP	SCREW 1/4-40 L=6		トメネシ* 1/4-40 L=6	(2)
29		B1219-850-0A0	OIL SHIELD ASM.		ウウシ*ク ア*ラ*リ クミ	1
30		SS-6110620-TP	SCREW 11/64-40 L= 5.5		ヒラネシ* 11/64-40 L=5.5	(1)
31		B1302-850-0A0	SPROCKET ASM.		ウウシ*ク スワ*ロ*ツト クミ	1
32		B1204-850-0A0	BALL BEARING ASM.		ウウシ*ク ウシロシ*クワク クミ	(1)
33		RO-4801201-00	RUBBER RING		オリック*	(1)
34		B1302-850-000	SPROCKET		ウウシ*ク スワ*ロ*ツト	(1)
35		SS-8660610-SP	SCREW 1/4-40 L=6		トメネシ* 1/4-40	(2)
36		B1217-850-000	HAND WHEEL		ウウシ*ク ハ*ミ*グ*ル*マ	1
37		SS-8661030-SP	SCREW 1/4-40 L=10		トメネシ* 1/4-40 L=10	2
38	#08	B1201-880-000-A	MAIN SHAFT		ウウシ*ク	1
39	#07	B1201-860-000-A	MAIN SHAFT		ウウシ*ク	1
40		B1213-552-0A0	OIL AMOUNT ADJUSTING PIN ASM.	D.07/79	クラック リヨ*チヨ*セツヒ*ン クミ	-
		B1213-552-0A0-A	OIL AMOUNT ADJUSTING PIN ASM.	A.07/79	クラック リヨ*チヨ*セツヒ*ン クミ	2
41		B1226-552-000	ROLLER FELT		フェルト	2
42		B1224-552-000	SCREW	D.07/79	クラック リヨ*チヨ*セツヒ*ン トメネシ*	-
43		B1301-850-000	TIMING BELT		タイミンク*ハ*ルト	1
44		B1815-850-0A0	THRUST COLLAR ASM.		シタシ*ク スラスト*ラ-	1
45		SS-8660330-SP	SCREW 1/4-40 L= 3.0		トメネシ* 1/4-40 L=3	(2)
46		B1803-850-000	LOWER SHAFT BUSHING B		シタシ*ク B メタル	1
47		B1807-850-0A0	LOWER SHAFT BALANCER ASM.	D.05/81	シタシ*ク ハ*ラ*ン*マ - クミ	-
48		B1807-850-000-A	BALANCER	D.05/81	シタシ*ク ハ*ラ*ン*マ -	-
49		B1809-850-000-A	BALANCER SET PLATE	D.05/81	シタシ*ク ハ*ラ*ン*マ - トメネシ*	-
50		SS-6111210-SP	SCREW 11/64-40 L=12	D.05/81	ヒラネシ* 11/64-40 L=12	-
51		B1804-850-000	LOWER SHAFT BUSHING C	D.05/81	シタシ*ク C メタル	-
51-1		B1804-850-000-A	LOWER SHAFT BUSHING C	A.05/81	シタシ*ク Cメタル	1
52		SS-8111251-SP	SCREW 11/64-40 L=12.0	D.12/79	トメネシ* 11/64-40 L=12	-
		SS-8151230-SP	SCREW 15/64-28 L=12	A.12/79	トメネシ* 15/64-28 L=12	1
53		B2551-850-0A0	NEEDLE GUARD ECCENTRIC CAM ASM.		ハリウ*ク ハ*ン*シ*ン*カム クミ	1
54		SS-8660612-TP	SCREW 1/4-40 L= 6.0		トメネシ* 1/4-40 L=6	(2)
55		B3541-850-0A0	WORM ASM.		ウオ*ム クミ	1
56		SS-8150710-SP	SCREW 15/64-28 L=7		トメネシ* 15/64-28 L=7	(2)
57		B1816-850-0A0	OIL SHIELD ASM.		シタシ*ク ア*ラ*リ クミ	1
58		SS-8110750-SP	SCREW 11/64-40 L= 6.5		トメネシ* 11/64-40 L=6.5	(1)
59		B1303-850-0A0	SPROCKET ASM		シタシ*ク スワ*ロ*ツト クミ	1
60		B1805-850-0A0	BALL BEARING ASM.		シタシ*ク ウシロシ*クワク クミ	(1)
61		RO-4301301-00	RUBBER RING		オリック*	(1)
62		B1304-850-000	SPROCKET FLANGE		スワ*ロ*ツト フランジ*	(1)
63		B1303-850-000	SPROCKET		シタシ*ク スワ*ロ*ツト	(1)
64		SS-8660610-SP	SCREW 1/4-40 L=6		トメネシ* 1/4-40	(2)
65		B1806-850-000	LOWER SHAFT HAND WHEEL		シタシ*ク ハ*ミ*グ*ル*マ	1
66		SS-8661030-SP	SCREW 1/4-40 L=10		トメネシ* 1/4-40 L=10	2

Note. (注記) 007. . . . . For MF-860, MF-870  
008. . . . . For MF-880, MF-890  
013. . . . . Selecting part

MF-860, MF-870機  
MF-880, MF-890機  
選択部品



# 6. FEED MECHANISM COMPONENTS (2)

## 送り関係 (2)

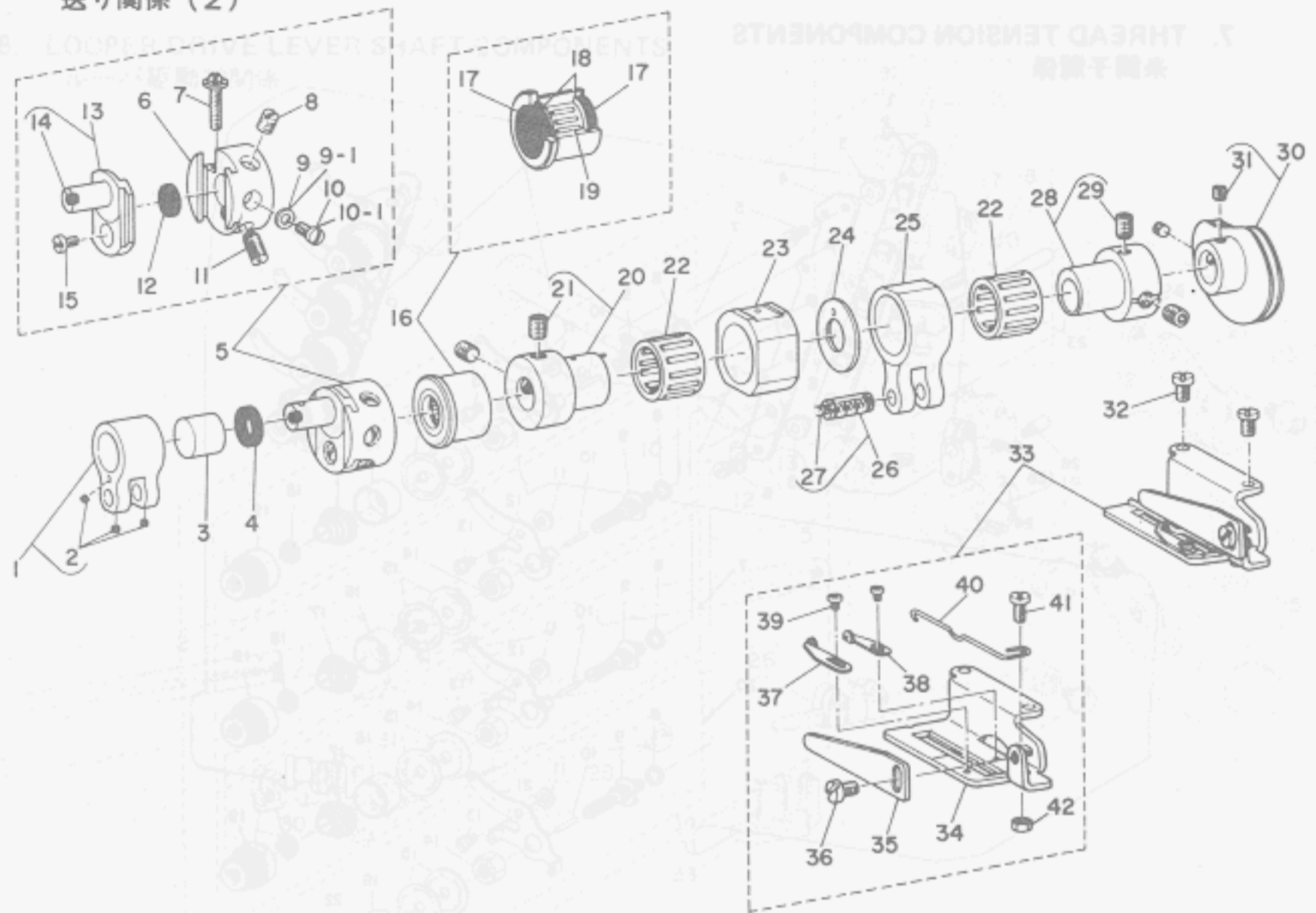

Ref. No.	Note	Part No	Description	E. C. 変更年月	品名	Amt. Req. 数量
1		B1608-850-0A0	FEED CRANK LINK ASM.		チヨセツタイ リンク クミ	1
2		R1633-850-000	RUBBER PLUG		オクリシク ヨトクワチトメシ	(3)
3		B1630-850-000	NEEDLE BEARING		チヨセツタイ ニトキ	1
4		B1631-850-000	OIL SEAL		チヨセツタイ オイルシール	1
5		B1611-850-0A0-A	FEED CRANK STUD BODY ASM.		オクリチヨセツタイ クミ	1
6		B1611-850-000	FEED CRANK STUD BODY		スイハイオクリ チヨセツタイ	(1)
7		B1624-850-000	STITCH REGULATING SCREW		オクリ チヨセツシ	(1)
8		SS-8150710-SP	SCREW 15/64-28 L=7		トメシ 15/64-28 L=7	(1)
9		WP-0371016-SD	WASHER 3.7X8X1	D,12/81	ヒラサカネ 3.7X8X1	-
9-1		WP-0482086-SD	WASHER 4.8X11.5X2.0	A,12/81	ヒラサカネ 4.8X11.5X2	(1)
10		SS-7090540-TP	SCREW 9/64-40 L=5	D,12/81	マルヒラネシ 9/64-40 L=5	-
10-1		SS-7110630-TP	SCREW 11/64-40	A,12/81	マルヒラネシ 11/64-40	(1)
11		SS-8151150-SP	SCREW 15/64-28 L=10.5		トメシ 15/64-28 L=10.5	(1)
12		B1627-850-000-A	PACKING		オクリチヨセツタイ ハツキ	(1)
13		B1612-850-0AA	FEED CRANK STUD ASM.		オクリチヨセツタイ クミ	(1)
14		TA-0370301-H0	PLUG D=3.9X4 L=3		トメシ D=3.9X4 L=3	(1)
15		SS-6090640-SP	SCREW 9/64-40 L=6.0		ヒラネシ 9/64-40 L=6	(1)
16		B1802-850-0A0	LOWER SHAFT BUSHING ASM, A		シタシクAメタキ クミ	1
17		B1813-850-000	OIL SEAL		シタシクAメタキ オイルシール	(2)
18		B1814-850-000	SNAP RING		シタシクAメタキ ニトキトメシ	(2)
19	◇13	B1812-850-800	NEEDLE BEARING		シタシク ニトキ B	(1)
20		B1702-850-0A0-A	FEED DRIVING ECCENTRIC CAM		シヨクオクリ ハジツカメ クミ	1
21		SS-8660612-TP	SCREW 1/4-40 L=6.0		トメシ 1/4-40 L=6	(2)
22	◇13	B1703-850-800	NEEDLE BEARING B		シヨクオクリ ニトキ B	2
23		B1625-850-000	FEED LIFTING BLOCK		スイハイ オクリサ	1
24		B1704-850-000-A	SPACER	D,12/78	スハク	-
		B1704-850-000-B	SPACER	A,12/78	スハク	1
25		B2523-850-000	LOOPER AVOID ECCENTRIC BUSHING		ルハク ヨトク リンク	1
26	◇13	B2527-850-BA0	PIN ASM.		ヨトク-リンクヒシク クミ	1
27		CQ-3030000-00	OIL WICK		ワシ	(0,1)
28		B2513-850-0A0	LOOPER AVOID ECCENTRIC CAM ASM.		ルハク ヒシク ハジツカメ クミ	1
29		SS-8660612-TP	SCREW 1/4-40 L=6.0		トメシ 1/4-40 L=6	(2)
30		B2201-860-0A0	CHAIN LOOPER THREAD GUIDE ASM.		シタイカメ クミ	1
31		SS-8110410-TP	SCREW 11/64-40 L=3.5		トメシ 11/64-40 L=3.5	(2)
32		SS-7110710-SP	SCREW 11/64-40 L=7		マルヒラネシ 11/64-40 L=7	2
33		B2204-850-0A0-A	LOOPER THREAD GUIDE PLATE ASM.		シタイ アツタイタ クミ	1
34		B2204-850-000-A	LOOPER THREAD GUIDE PLATE		シタイ アツタイタ	(1)
35		B2205-850-000	RETAINING FINGER		シタイカメ オサ	(1)
36		SS-7110510-SP	SCREW 11/64-40 L=5		マルヒラネシ 11/64-40 L=5	(1)
37		B2208-850-000	THREAD EYELET, LEFT		シタイカメ イトアサ ヒサリ	(1)
38		B2209-850-000	THREAD EYELET, RIGHT		シタイカメ イトアサ ミサ	(1)
39		SS-7060310-SP	SCREW 3/32-56 L=3		マルヒラネシ 3/32-56 L=3	(2)
40		B2207-850-000	GUIDE WIRE		シタイカメ アツタイタ	(1)
41		SS-7110710-SP	SCREW 11/64-40 L=7		マルヒラネシ 11/64-40 L=7	(1)
42		NS-6110310-SP	NUT 11/64-40		ワシカクナツ 11/64-40	(1)

Note. (注記) ◇13. . . . . Selecting part 選択部品

# 7. THREAD TENSION COMPONENTS

糸調子関係

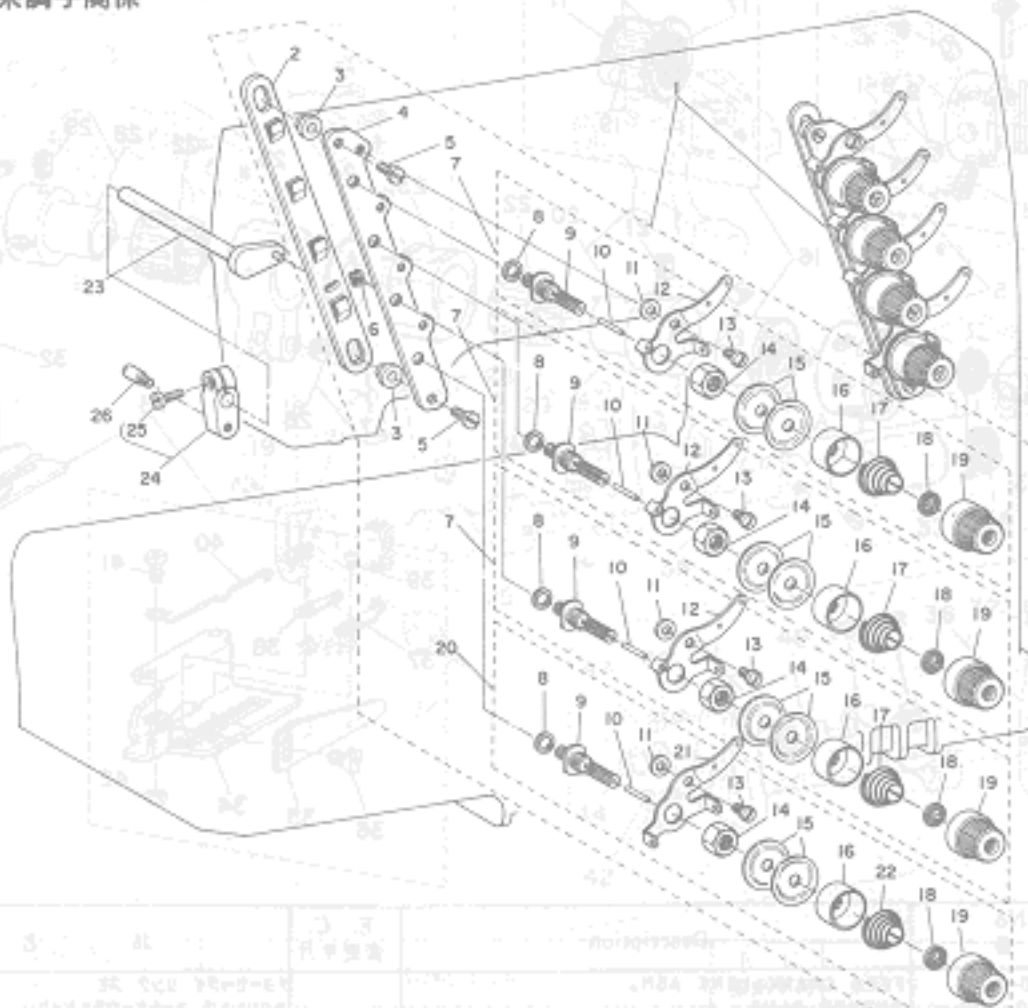

Ref. No.	Note	Part No.	Description	E. C. 変更年月	品名	Amt. Req. 数量
1		83105-870-0B0	TENSION POST ASM.		イトヨロシ クミ	1
2		83106-850-000	TENSION DISC SEPARATOR		イトヨロシ	(1)
3		83107-850-000	THREAD TENSION DISC PLATE		イトヨロシ ク	(2)
4		83105-850-000	TENSION POST SUPPORT		イトヨロシ トリツケ	(1)
5		SS-7111410-SP	SCREW 11/64-40 L=14		ワヒラネ 11/64-40 L=14	(2)
6		WZ-0430200-KH	WAVED WASHER		ワズカ 97*カ	(1)
7		83105-870-0A0	TENSION POST ASM.		イトヨロシ クミ	(3)
8		83115-850-000	WASHER		イトヨロシカ 7*カ	(4)
9		83110-850-000	TENSION POST		イトヨロシカ	(4)
10		83111-850-000	TENSION RELEASE PIN		イトヨロシワラ ヌムピン	(4)
11		83108-850-000	NEEDLE GUIDE SPACER		イトンアイ スパ	(4)
12		83109-850-000	NEEDLE GUIDE		イトンアイ	(3)
13		SS-5110810-SP	SCREW 11/64-40 L=8		トラスネ 11/64-40 L=8	(4)
14		NS-6240630-SP	HUT 3/8-18		60ナツト 3/8-18	(4)
15		83126-012-000	TENSION DISC		イトヨロシワ	(4)
16		83107-804-000	TENSION DISC PRESSER TUBE		イトヨロシワ 277	(6)
17		83129-012-A00	TENSION SPRING		イトヨロシワ A	(3)
18		83120-125-000	TENSION DISC STOPPER		イトヨロシワ カイラント	(4)
19		83119-771-000	TENSION NUT		イトヨロシワツ	(4)
20		83105-870-0AA	TENSION POST ASM.		イトヨロシカ クミ	(1)
21		83112-850-000	LOOPER THREAD LEAD-IN GUIDE		シタイト イトンアイ	(1)
22		82017-372-000	TENSION SPRING NO.1		タニ イトヨロシワ	(1)
23		83102-850-0A0	THREAD RELEASE LEVER SHAFT ASM.		イトヨロシク クミ	1
24		83104-850-0A0	RELEASE LEVER SHAFT CONNECTION ASM.		イトヨロシク ツナイク クミ	1
25		SS-6121210-SP	SCREW 3/16-28 L=12		ヒラネ 3/16-28 L=12	(1)
26		83103-850-000	HINGE STUD		ツナイクワ ヒ	1

# 9. LOOPER COMPONENTS

ルーバ関係

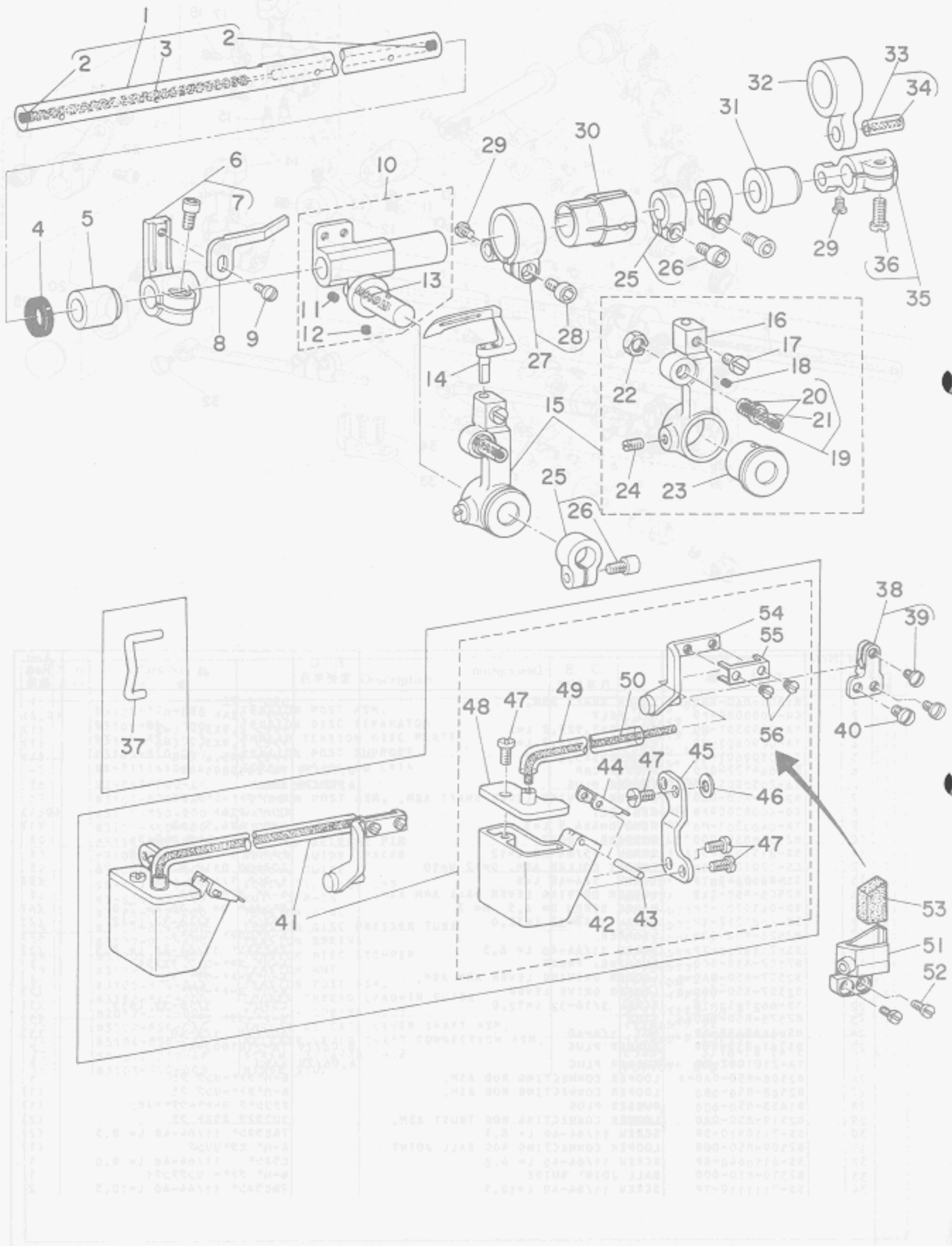

Ref. No.	Note 注記	Part No. 品番	Description	E. C. 変更年月	品名	Amt. Req. 数量
1		B2516-850-0A0-A	LOOPER ROCKER SHAFT ASM.		ル=ハ°シク クミ	1
2		TA-0500601-M0	PLUG D=5X5,4 L=6		トメセン 5X5,4 L=6	(2)
3		CQ-3000000-F0	OIL FELT	0,03/79	ロツト° フィルト	-
4		B2526-850-000	OIL SEAL		ル=ハ°シク オイルシール	1
5		B2520-850-000-A	BUSHING, FRONT		ル=ハ°シク マメタル	1
6		B2554-850-0A0-B	NEEDLE GUARD HOLDER ASM.		ハリウケタイ クミ	1
7		SS-6621212-TP	SCREW 3/16-32 L=12,0		ヒラネシ° 3/16-32 L=12	(1)
8		B2555-860-000-A	NEEDLE GUARD		ハリウケ	1
9		SS-7090910-SP	SCREW 9/64-40 L= 8,5		マルヒラネシ° 9/64-40 L= 8,5	1
10		B2522-850-0A0	LOOPER ROCKER FRAME COLLAR ASM.		ル=ハ° トリツケウチ° ツグイ クミ	1
11		TA-0400301-M0	PLUG D=4X4,5 L=3		トメセン 4X4,5 L=3	(1)
12		TA-0180401-M0	PLUG D=1,8X2,1 L=4		トメセン 1,8X2,1 L=4,3	(1)
13		CQ-4000000-F0	OIL FELT		ロツト° フィルト	(0,1)
14		B2514-860-G00	LOOPER G		ル=ハ° G	1
15		B2512-850-0B0	LOOPER ROCKER ASM.		トリツケ ウチ° クミ	1
16		B2512-850-000	LOOPER ROCKER		ル=ハ° トリツケウチ°	(1)
17		SS-6620730-SP	SCREW 3/16-32 L= 7,0		ヒラネシ° 3/16-32 L= 7	(1)
18		TA-0180401-M0	PLUG D=1,8X2,1 L=4		トメセン 1,8X2,1 L=4,3	(1)
19		B2511-850-0A0	BALL JOINT ASM.		ル=ハ° ヒタ° リンクシク クミ	(1)
20		TA-0290301-M0	PLUG D=2,9X3,2 L=3		トメセン 2,9X3,2 L=3	(2)
21		CQ-3000000-F0	OIL FELT		ロツト° フィルト	(0,1)
22		NS-6660430-SP	NUT 1/4-40		6カクナツト 1/4-40	(1)
23		B2515-850-000	LOOPER ROCKER BUSHING		トリツケウチ° メタル	(1)
24		SS-8110750-SP	SCREW 11/64-40 L= 6,5		トメネシ° 11/64-40 L=6,5	(1)
25		B2524-850-0A0	THRUST BUSHING ASM.		ル=ハ° トリツケウチ° ツグイ スラストウケ	3
26		SS-6621212-TP	SCREW 3/16-32 L=12,0		ヒラネシ° 3/16-32 L=12	(3)
27		B2517-850-0A0	THRUST ROCKER SHAFT ARM ASM.		ル=ハ° セ°ンコ° ヨト°-ウチ° クミ	1
28		SS-6621212-TP	SCREW 3/16-32 L=12,0		ヒラネシ° 3/16-32 L=12	(1)
29		SS-7090510-SP	SCREW 9/64-40 L= 4,6		マルヒラネシ° 9/64-40 L= 4,6	2
30		B2518-850-000	BUSHING		ル=ハ° セ°ンコ°ウチ° ツグイ	1
31		B2521-850-000	BUSHING, REAR		ル=ハ°シク ウシロメタル	1
32		B2552-850-000-A	LOOPER DRIVE LEVER LINK		ハリウケヨト°-リンク	1
33	◇13	B2527-850-BA0	PIN ASM.		ヨト°-リンクヒ°ン クミ	1
34		CQ-3030000-00	OIL WICK		ウシシ	(0,1)
35		B2553-850-0A0	LOOPER DRIVING LEVER ASM.		ハリウケ ヨト°-ウチ° クミ	1
36		SS-7151120-SP	SCREW 15/64-28 L=11		マルヒラネシ° 15/64-28 L=11	(1)
37	◇15	B2558-860-000	FRONT NEEDLE GUARD		マエハリウケ	1
38		B2559-860-0A0	FRONT NEEDLE GUARD HOLDER ASM.		マエハリウケタイ クミ	1
39		SS-7090620-TP	SCREW 9/64-40 L= 6,1		マルヒラネシ° 9/64-40 L= 6,1	(1)
40		SS-7090710-SP	SCREW 9/64-40 L= 6,8		マルヒラネシ° 9/64-40 L= 6,8	2
41	◇16	B9208-850-0B0	NEEDLE HEAT REMOVER ASM.	D,02/80	ハリ レイヤクソ°チ クミ	-
	◇16	B9220-850-0B0	NEEDLE HEAT REMOVER ASM.	A,02/80	ハリレイヤクツ°フィルト クミ	1
42	◇16	B9206-850-000	SILICONE OIL TANK, LOWER		イスレンタンク シタ	(1)
43	◇16	PS-0160162-KH	SPRING PIN 1,6X16		スフ°リンク°ヒ°ン 1,6X16	(1)
44	◇16	B9205-850-000	SILICONE OIL TANK COVER, LOWER		イスレンタンク フタ	(1)
45	◇16	B9207-850-000	TANK INSTALLING PLATE		タンクトリツケイタ	(1)
46	◇16	WP-0501016-SD	WASHER 5X10,5X1		ヒラサ°カ°ネ 5X10,5X1	(1)
47	◇16	SS-7110740-TP	SCREW 11/64-40 L=7		マルヒラネシ° 11/64-40 L= 7	(4)
48	◇16	B9204-850-0A0	SILICONE OIL TANK PLATE ASM.		イスレンタンク イタ クミ	(1)
49	◇16	BP-5000000-00	VINYL TUBE, WHITE D=5		ヒ°ニール ハ°イフ°	(0,1)
50	◇16	CQ-3030000-00	OIL WICK	D,02/80	ウシシ	-
	◇16	CQ-4000000-F0	OIL FELT	A,02/80	ロツト° フィルト	(0,2)
51	◇16	B9208-850-0A0	NEEDLE HEAT REMOVER BRACKET ASM.	D,02/80	ハリ レイヤクウケ クミ	-
52	◇16	SS-7090910-SP	SCREW 9/64-40 L= 8,5	D,02/80	マルヒラネシ° 9/64-40 L= 8,5	-
53	◇16	B9203-850-000	HEAT REMOVING FELT	D,02/80	ハリ レイヤク フィルト	-
54	◇16	B9220-850-0A0	FELT INSTALLING PLATE ASM.	A,02/80	フィルトトリツケイタ クミ	(1)
55	◇16	B9222-850-000	FELT HOLDER	A,02/80	フィルト	(1)
56	◇16	SS-4060310-SP	SCREW 3/32-56 L=2,5	A,02/80	ナ°°シ° 3/32-56 L= 2,5	(2)

Note.(注記)◇13. . . . . Selecting part 選択部品  
 ◇15. . . . . Standard part 輸出用  
 ◇16. . . . . Special order part 国内用



# 10. LUBRICATION COMPONENTS

給油関係 COMPONENTS

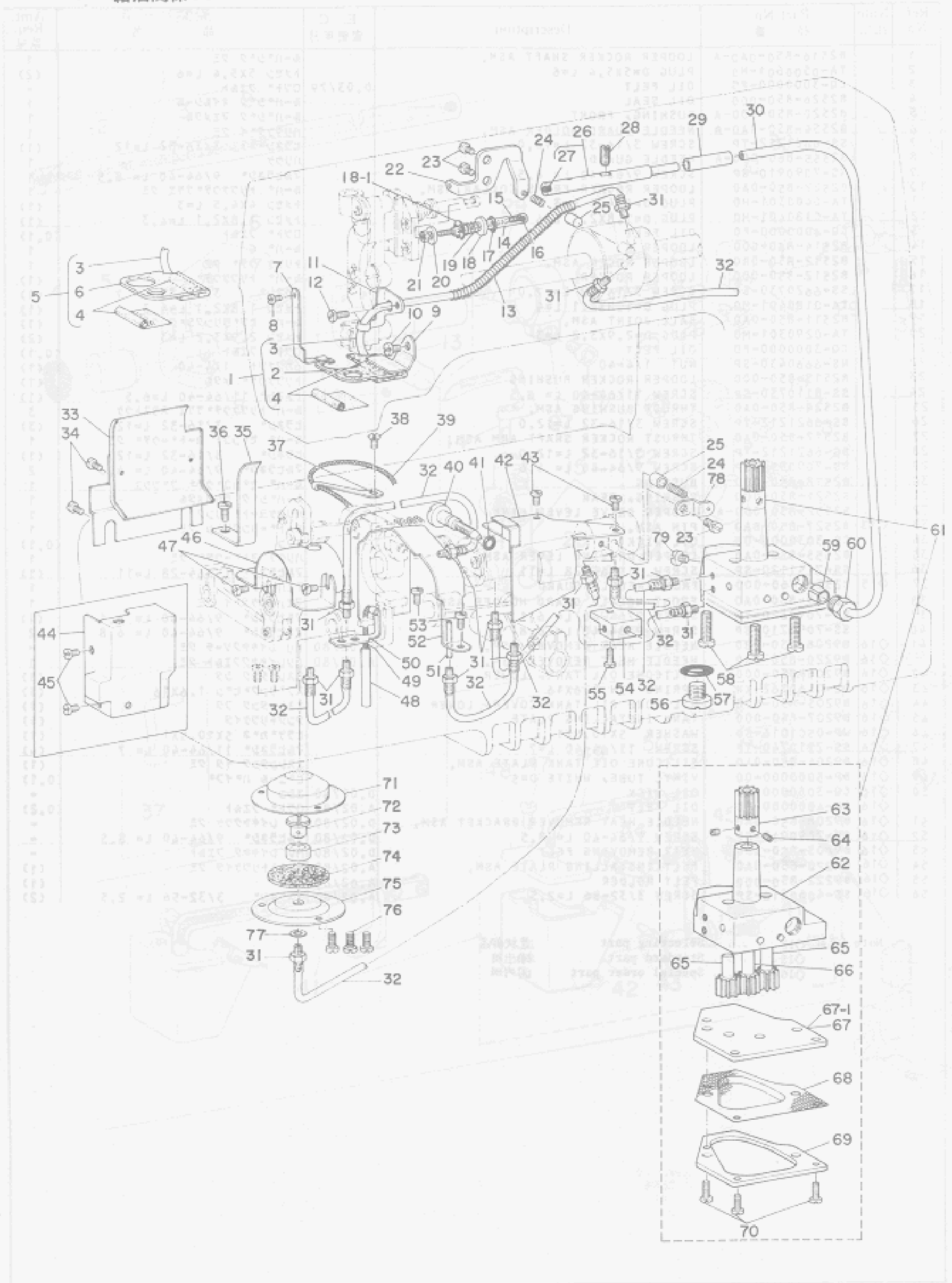

Ref. No.	Note 注記	Part No. 品番	Description	E. C. 変更年月	品名	Amt. Req. 数量
1	◇08	B3515-880-0A0-A	OIL RETURN TUBE ASM.		カンリユ-ハ <sup>○</sup> イフ <sup>○</sup> クミ	1
2	◇08	B3515-880-000-A	OIL RETURN FELT		カンリユ-フエルト	(1)
3		B3568-771-000	OIL RETURN TUBE		カンリユ-ハ <sup>○</sup> イフ <sup>○</sup>	(1)
4		B3534-850-000	OIL UNWOVEN CLOTH		カンリユ-ハ <sup>○</sup> イフ <sup>○</sup> アテ	(1)
5	◇07	B3515-850-0A0	OIL RETURN TUBE ASM.		カンリユク ハ <sup>○</sup> イフ <sup>○</sup> クミ	1
6	◇07	B3515-850-000	OIL FELT		カンリユ-フエルト	(1)
7		B3516-880-000	OIL FELT PRESSER A		カンリユ-フエルトオサエ A	1
8		SS-7090520-SP	SCREW 9/64-40 L= 4,5		マルヒラネシ <sup>○</sup> 9/64-40 L=4,5	1
9		B3516-850-000	OIL RETURN FELT HOLDER		カンリユ-フエルトオサエ	1
10		SS-7110740-TP	SCREW 11/64-40 L=7		マルヒラネシ <sup>○</sup> 11/64-40 L=7	1
11		B3519-850-000	OIL TUBE HOLDER		ハ <sup>○</sup> イフ <sup>○</sup> オサエ	1
12		SS-7110740-TP	SCREW 11/64-40 L=7		マルヒラネシ <sup>○</sup> 11/64-40 L=7	1
13		B3404-122-000	SPRING		ハ <sup>○</sup> ス	1
14		B3555-850-000	OIL TUBE		アンナイタイ キュ-2ハ <sup>○</sup> イフ <sup>○</sup>	1
15		CQ-3000000-FO	OIL FELT		ロツト <sup>○</sup> フエルト	0,1
16		TA-0370301-HO	PLUG D=3,9X4 L=3		トメセン D=3,9X4 L=3	1
17		RO-0552001-00	RUBBER RING		オリツク <sup>○</sup>	1
18		WP-0612066-SP	WASHER 11,0X6,1X2	M,12/78	ヒラサ <sup>○</sup> カ <sup>○</sup> 6,1X11X2	1
18-1		RE-0500000-KO	SNAP RING 5	A,12/78	エカ <sup>○</sup> タ <sup>○</sup> メ <sup>○</sup> ウ 5	1
19		B4115-704-000	SPRING		スライト <sup>○</sup> シ <sup>○</sup> ク トメ <sup>○</sup> シ <sup>○</sup> ハ <sup>○</sup> ス	1
20		WP-0482086-SD	WASHER 4,8X11,5X2,0		ヒラサ <sup>○</sup> カ <sup>○</sup> 4,8X11,5X2	1
21		NS-6110420-SP	NUT 11/64-40		ロツクアツト 11/64-40	1
22		B3542-850-000-A	PLUNGER PRESSER PLATE		フ <sup>○</sup> ランシ <sup>○</sup> ヤ <sup>○</sup> オサエ <sup>○</sup> イ <sup>○</sup> ヲ	1
23		SS-7110740-TP	SCREW 11/64-40 L=7	M,05/81	マルヒラネシ <sup>○</sup> 11/64-40 L=7	3
24		B1214-038-000	PLUNGER SPRING	M,05/81	フ <sup>○</sup> ランシ <sup>○</sup> ヤ <sup>○</sup> オサエ <sup>○</sup> ハ <sup>○</sup> ス	2
25		B3534-155-000	PLUNGER	M,05/81	フ <sup>○</sup> ランシ <sup>○</sup> ヤ <sup>○</sup>	2
26		B3508-850-000-A	OIL TUBE JOINT A		キュ-2 シ <sup>○</sup> ヨ <sup>○</sup> イント A	1
27		B3508-850-00A	PLUG		キュ-2シ <sup>○</sup> ヨ <sup>○</sup> イント トメセン	(1)
28		SS-8151230-SP	SCREW 15/64-28 L=12		トメネシ <sup>○</sup> 15/64-28 L=12	1
29		B3509-850-000	RUBBER JOINT		キュ-2 ハ <sup>○</sup> イフ <sup>○</sup> コ <sup>○</sup> ム	1
30		B3507-850-000	OIL TUBE		ウツシ <sup>○</sup> ク キュ-2ハ <sup>○</sup> イフ <sup>○</sup>	1
31		SQ-1110401-MZ	CONNECTING SCREW	M,05/81	キュ-2 <sup>○</sup> レ <sup>○</sup> ン <sup>○</sup> ク <sup>○</sup> ツ <sup>○</sup> ネシ <sup>○</sup>	14
32		BP-3000000-OR	VINYL TUBE	D,02/80	BT-0500300-E0	-
33		BT-0500300-E0	OIL TUBE	M,05/81	ウレタン チュ-フ <sup>○</sup> D=3X5	0,5
34		B3544-850-000	FEED ROCKER ARM OIL SHIELD		オクリタイ ヨ-ト <sup>○</sup> -ウチ <sup>○</sup> 2 <sup>○</sup> ス <sup>○</sup> -イ <sup>○</sup> ヲ	1
35		SS-7150740-SP	SCREW 15/64-28 L=7		マルヒラネシ <sup>○</sup> 15/64-28 L=7	2
36		B3536-850-000	OIL SHIELD		シ <sup>○</sup> ヨ <sup>○</sup> ネ <sup>○</sup> カ <sup>○</sup> カ <sup>○</sup> ム 2 <sup>○</sup> ス <sup>○</sup> -ハ <sup>○</sup> ン	1
37		SS-5110810-SP	SCREW 11/64-40 L=8		トラスネシ <sup>○</sup> 11/64-40 L=8	1
38		B3506-761-000	OIL WICK HOLDER		シ <sup>○</sup> タ カ <sup>○</sup> ハ <sup>○</sup> ク <sup>○</sup> ル <sup>○</sup> マ <sup>○</sup> 2 <sup>○</sup> シ <sup>○</sup> ン <sup>○</sup> オ <sup>○</sup> サ <sup>○</sup> エ	1
39		SS-6090630-SP	SCREW 9/64-40 L=6	D,06/79	ヒラネシ <sup>○</sup> 9/64-40 L=6	-
40		SS-7110740-TP	SCREW 11/64-40 L=7	A,06/79	マルヒラネシ <sup>○</sup> 11/64-40 L=7	1
41		CQ-3000000-FO	OIL FELT		ロツト <sup>○</sup> フエルト	0,1
42		B3514-850-000	ADJUSTING SCREW		シ <sup>○</sup> タ <sup>○</sup> シ <sup>○</sup> ク 2 <sup>○</sup> リ <sup>○</sup> ヨ <sup>○</sup> チ <sup>○</sup> ヨ <sup>○</sup> -セ <sup>○</sup> ツ <sup>○</sup> ネシ <sup>○</sup>	1
43		RO-0481901-00	RUBBER RING		オリツク <sup>○</sup>	1
44		B3512-850-000-B	LOOPER OIL SHIELD, RIGHT		ル <sup>○</sup> -ハ <sup>○</sup> ミ <sup>○</sup> キ <sup>○</sup> 2 <sup>○</sup> ス <sup>○</sup> -ハ <sup>○</sup> ン	1
45	◇15	SS-7110740-TP	SCREW 11/64-40 L=7		マルヒラネシ <sup>○</sup> 11/64-40 L=7	2
46	◇15	B3513-850-000-A	LOOPER OIL SHIELD, LEFT		ル <sup>○</sup> -ハ <sup>○</sup> ヒ <sup>○</sup> タ <sup>○</sup> リ <sup>○</sup> カ <sup>○</sup> ハ <sup>○</sup>	1
47	◇15	SS-7110510-SP	SCREW 11/64-40 L=5		マルヒラネシ <sup>○</sup> 11/64-40 L=5	2
48		B3510-850-000	OIL SHIELD		オクリカ <sup>○</sup> ム 2 <sup>○</sup> ス <sup>○</sup> -ハ <sup>○</sup> ン	1
49		SS-7110510-SP	SCREW 11/64-40 L=5		マルヒラネシ <sup>○</sup> 11/64-40 L=5	2
50		B3522-850-000	OIL PIPE		ハ <sup>○</sup> イフ <sup>○</sup>	1
51		CQ-3000000-FO	OIL FELT		ロツト <sup>○</sup> フエルト	0,1
52		B3521-850-000	OIL WICK HOLDER		リンク アンナイ 2 <sup>○</sup> シ <sup>○</sup> ン <sup>○</sup> オ <sup>○</sup> サ <sup>○</sup> エ	1
53		CQ-3000000-FO	OIL FELT		ロツト <sup>○</sup> フエルト	0,1
54		B3511-850-000	LOWER SHAFT OIL SHIELD		シ <sup>○</sup> タ <sup>○</sup> シ <sup>○</sup> ク 2 <sup>○</sup> ス <sup>○</sup> -イ <sup>○</sup> ヲ	1
55		SS-7110740-TP	SCREW 11/64-40 L=7		マルヒラネシ <sup>○</sup> 11/64-40 L=7	2
56		B3550-850-000	OIL SEPARATING BLOCK	D,05/81	キュ-2 フ <sup>○</sup> ン <sup>○</sup> ハ <sup>○</sup> イ <sup>○</sup> ヲ <sup>○</sup> イ	-
57		SS-7110910-SP	SCREW 11/64-40 L= 8,5	D,05/81	マルヒラネシ <sup>○</sup> 11/64-40 L=8,5	-
58		SS-6741010-SP	SCREW 3/8-28 L=10		ヒラネシ <sup>○</sup> 3/8-28 L=10	1
59		B8219-125-000	OIL DRAIN CAP GASKET		ハイ <sup>○</sup> ア <sup>○</sup> ア <sup>○</sup> ツ <sup>○</sup> ハ <sup>○</sup> ツ <sup>○</sup> キ <sup>○</sup> ン	1
60		SS-6151920-SP	SCREW 15/64-28 L=19,0		ヒラネシ <sup>○</sup> 15/64-28 L=19	3
61		B3511-122-000	OIL TUBE CLAMPING SLEEVE		ハ <sup>○</sup> イフ <sup>○</sup> コ <sup>○</sup> タイ <sup>○</sup> ツ <sup>○</sup> シ <sup>○</sup>	1
62		B3512-122-000	OIL TUBE CLAMPING SCREW		ハ <sup>○</sup> イフ <sup>○</sup> コ <sup>○</sup> タイ <sup>○</sup> ネシ <sup>○</sup>	1
63		B3501-850-0A0	OIL PUMP ASM.		キュ-2 <sup>○</sup> キ <sup>○</sup> ン <sup>○</sup> フ <sup>○</sup> ク <sup>○</sup> イ <sup>○</sup> クミ	1
64		B3501-850-000	LUBRICATION OIL PUMP HOUSING		キュ-2 <sup>○</sup> キ <sup>○</sup> ン <sup>○</sup> フ <sup>○</sup> ク <sup>○</sup> イ <sup>○</sup>	(1)
65		B3513-804-000	WORM GEAR		ウ <sup>○</sup> オ <sup>○</sup> -ム ハ <sup>○</sup> ク <sup>○</sup> ル <sup>○</sup> マ <sup>○</sup>	(1)
66		SS-8110410-SP	SCREW 11/64-40 L=3,5		トメネシ <sup>○</sup> 11/64-40 L=6,5	(2)
67		B3504-352-0A0	PINION SHAFT ASM.		<sup>○</sup> キ <sup>○</sup> ヤ <sup>○</sup> キ <sup>○</sup> ン <sup>○</sup> フ <sup>○</sup> ク <sup>○</sup> イ <sup>○</sup> クミ	(2)
68		B3505-850-0A0	OIL PUMP DRIVING SHAFT ASM.		<sup>○</sup> キ <sup>○</sup> ヤ <sup>○</sup> キ <sup>○</sup> ン <sup>○</sup> フ <sup>○</sup> ク <sup>○</sup> イ <sup>○</sup> クミ	(1)
69		B3502-850-000	OIL PUMP HOUSING COVER	D,05/81	キュ-2 <sup>○</sup> キ <sup>○</sup> ン <sup>○</sup> フ <sup>○</sup> ク <sup>○</sup> イ <sup>○</sup>	-
70	67-1	B3502-850-000-A	OIL PUMP HOUSING COVER	A,05/81	キュ-2 <sup>○</sup> キ <sup>○</sup> ン <sup>○</sup> フ <sup>○</sup> ク <sup>○</sup> イ <sup>○</sup>	(1)
71		B3556-850-000	FILTER SCREEN		ロカ <sup>○</sup> モ <sup>○</sup> ウ	(1)
72		B3557-850-000	FILTER SCREEN RETAINER		ロカ <sup>○</sup> モ <sup>○</sup> ウ オサ <sup>○</sup> エ <sup>○</sup> イ <sup>○</sup> ヲ	(1)
73		SS-7110910-TP	SCREW 11/64-40 L= 8,5		マルヒラネシ <sup>○</sup> 11/64-40 L=8,5	(3)
74		B1173-850-000	FILTER SCREEN	A,05/81	ロカ <sup>○</sup> モ <sup>○</sup> ウ	1
75		B3560-850-000	PIN	A,05/81	カンリユ-ピン	1
76		B3558-850-000	FELT A	A,05/81	カンリユ-フエルト A	1
77		B3559-850-000	FELT B	A,05/81	カンリユ-フエルト B	1
78		B3561-850-000	FILTER COVER	A,05/81	カンリユ-フタ	1
79		SS-7090710-SP	SCREW 9/64-40 L= 6,8	A,05/81	マルヒラネシ <sup>○</sup> 9/64-40 L=6,8	3
80		WP-0450801-SD	WASHER 4,5X10,0X0,8	A,05/81	ヒラサ <sup>○</sup> カ <sup>○</sup> 4,5X10X0,8	1
81		B3563-850-000	PLUNGER PRESSER PLATE	A,05/81	フ <sup>○</sup> ランシ <sup>○</sup> ヤ <sup>○</sup> オサ <sup>○</sup> エ <sup>○</sup> イ <sup>○</sup> ヲ	1
82		SS-7110510-SP	SCREW 11/64-40 L=5	A,05/81	マルヒラネシ <sup>○</sup> 11/64-40 L=5	1

Note (注記) ◇07. . . . . For MF-860, MF-870 MF-860, MF-870 用  
 ◇08. . . . . For MF-880, MF-890 MF-880, MF-890 用  
 ◇15. . . . . Standard part 輸出用

# 11. SPREADER & PRESSER FOOT LIFTER COMPONENTS

スプレッダー、押エ上げ関係

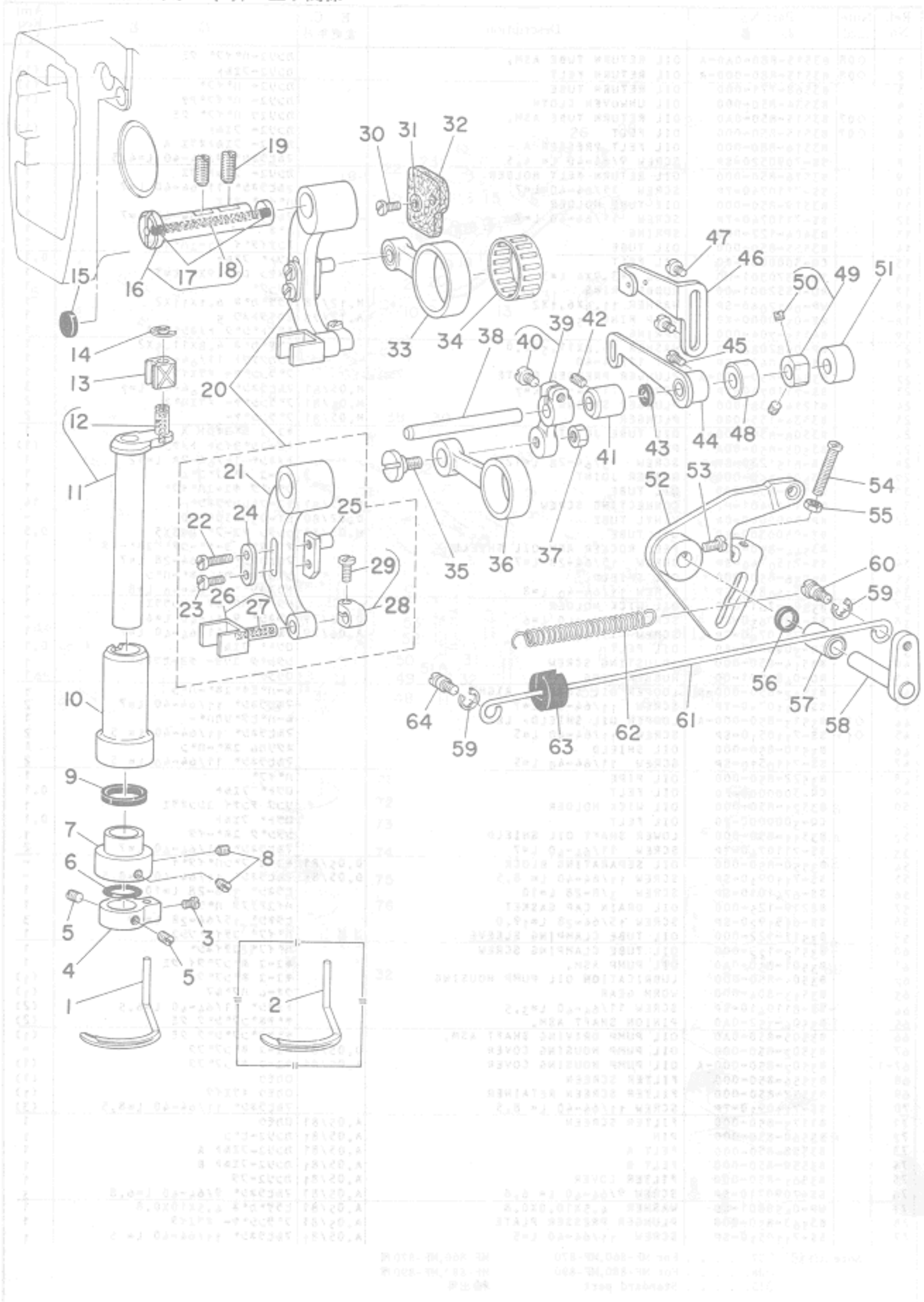

PROT. 2M 200 2M  
 2002-2M 200 2M  
 2002-2M 200 2M

Ref. No.	Note	Part No.	Description	E. C. 変更年月	品名	Arnt. Req. 数量
1	08	83901-880-A00	SPREADER A		スプレッタ - A	1
2	17	83901-880-000	SPREADER		スプレッタ	1
3	08	SS-7080510-SP	SCREW 1/8-44 L=4.5	0.09/80	SS-7080510-TP	-
4	08	SS-7080510-TP	SCREW 1/8-44 L=4.5	A.09/80	マルヒラネシ 1/8-44 L=4.5	1
5	08	83902-880-000	SPREADER HOLDER		スプレッタ - トリツクウチ	1
6	08	SS-8110410-TP	SCREW 11/64-40 L=3.5		トメネシ 11/64-40 L=3.5	2
7	08	RO-1372301-00	RUBBER RING		Oリング	1
8	08	83906-880-000-A	SPREADER COLLAR		スプレッタ - トリツクウチ カラー	1
9	08	SS-8110750-SP	SCREW 11/64-40 L=6.5		トメネシ 11/64-40 L=6.5	2
10	08	83935-880-000	OIL SEAL		スプレッタ - シクメタル オイルシール	1
11	08	83904-880-000-A	SPREADER BAR BUSHING		スプレッタ - シクメタル	1
12	08	83903-880-0A0	SPREADER BAR ASM.		スプレッタ - シク クミ	1
13	08	CQ-2020000-00	OIL WICK		ワック	(0.1)
14	08	83913-880-000-A	SPREADER SLIDE BLOCK		スプレッタ - コロ	1
15	08	RE-0500000-K0	SNAP RING 5		Eカクメワ 5	1
16	07	B2015-357-000	PLUG		ニシユカンシク クシロメタル プラ	1
17	08	83911-880-0A0-A	SPREADER ROCKER SHAFT ASM.		スプレッタ - ウチシク クミ	1
18	08	TA-0370301-M0	PLUG D=3.9X4 L=3		トメネシ D=3.9X4 L=3	(2)
19	08	CQ-3000000-F0	OIL FELT		ワック	(0.1)
20	08	SS-8151230-SP	SCREW 15/64-28 L=12		トメネシ 15/64-28 L=12	2
21	08	83910-880-0A0	SPREADER ROCKER SHAFT ARM ASM.		スプレッタ - ウチ クミ	1
22	08	83910-880-000	SPREADER ROCKER SHAFT ARM		スプレッタ - ウチ	(1)
23	08	SS-7111410-TP	SCREW 11/64-40 L=14		マルヒラネシ 11/64-40 L=14	(1)
24	08	SS-7110910-TP	SCREW 11/64-40 L=8.5		マルヒラネシ 11/64-40 L=8.5	(1)
25	08	83917-880-000	WASHER		ワッシャー	(1)
26	08	83914-880-000	SPREADER ROCKER SHAFT LINK		スプレッタ - リンクシク	(1)
27	08	83912-880-0A0	SPREADER CONNECTING ROD ASM.		コワタマタ クミ	(1)
28	08	CQ-2020000-00	OIL WICK		ワック	(0.1)
29	08	B2519-850-0A0	LOOPER CONNECTING ROD TRUST ASM.		コワタマタ スラスト クミ	(1)
30	08	SS-7110910-SP	SCREW 11/64-40 L=8.5		マルヒラネシ 11/64-40 L=8.5	(1)
31	08	SS-7110740-TP	SCREW 11/64-40 L=7		マルヒラネシ 11/64-40 L=7	1
32	08	WP-0501016-S0	WASHER 5X10,5X1		ワッシャー 5X10,5X1	1
33	08	83915-880-000	OIL FELT		スプレッタ - ワック	1
34	08	83908-880-0A0	SPREADER DRIVING LINK ASM.		スプレッタ - リンク クミ	1
35	08	83909-880-800	NEEDLE BEARING B		スプレッタ - リンク ニットル B	1
36	08	SD-0870602-SP	HINGE SCREW D=8.73 H=6.0		クミネシ D=8.73 H=6	1
37	08	83921-880-000	THREAD PULL-OFF CAM CONNECTING ROD		スプレッタ - テンヒンカム ロット	1
38	08	NS-6150310-SP	NUT 15/64-28		ワッシャーナット 15/64-28	1
39	08	83923-880-000	SPREADER PULL-OFF LEVER SHAFT		スプレッタ - テンヒンシク	1
40	08	83922-880-0A0	PULL-OFF LEVER DRIVING ARM ASM.		スプレッタ - テンヒンシク - ウチ クミ	1
41	08	SS-7111120-SP	SCREW 11/64-40 L=10.5		マルヒラネシ 11/64-40 L=10.5	(1)
42	08	83924-880-000-A	BUSHING A		テンヒンシク クワ A	1
43	08	SS-8110750-SP	SCREW 11/64-40 L=6.5		トメネシ 11/64-40 L=6.5	1
44	08	83936-880-000	OIL SEAL		スプレッタ - テンヒン オイルシール	1
45	08	83926-880-0A0-A	SPREADER THREAD PULL-OFF LEVER ASM.		スプレッタ - テンヒン クミ	1
46	08	SS-7110810-SP	SCREW 11/64-40 L=8.0		マルヒラネシ 11/64-40 L=8	1
47	08	83927-880-000	SPREADER PULL-OFF THREAD GUIDE		スプレッタ - テンヒン イアツナイ	1
48	08	SS-6110480-SP	SCREW 11/64-40 L=4.3		ヒラネシ 11/64-40 L=4.3	2
49	08	83925-880-000	SHAFT RETAINER B		スプレッタ - テンヒン シク クワ B	1
50	08	CS-064086B-SH	THRUST COLLAR ASM, D=6.35 W=8		スラストクワ D=6.35 W=8 クミ	1
51	08	SS-8110320-SP	SCREW 11/64-40 L=3.2		トメネシ 11/64-40 L=3.2	(2)
52	08	B1189-038-000	PLUG		ツリネ - アナキツツ	1
53	08	83401-850-0A0	PRESSER BAR LIFTING LEVER ASM.		オウエアク レバ - クミ	1
54	08	SS-6661110-SP	SCREW 1/4-40 L=11		ヒラネシ 1/4-40 L=11	1
55	08	SS-7112420-SP	SCREW 11/64-40 L=24		マルヒラネシ 11/64-40 L=24	1
56	08	NS-6110310-SP	NUT 11/64-40		ワッシャーナット 11/64-40	1
57	08	83406-850-000	OIL SEAL		オイルシール	1
58	08	83405-850-000	BUSHING		オウエアク シクメタル	1
59	08	83403-850-0A0	LIFTING LEVER SHAFT ASM.		オウエアク レバ - シク クミ	1
60	08	RE-0500000-K0	SNAP RING 5		Eカクメワ 5	2
61	08	83418-850-000	HINGE SCREW		オウエアク ヨコネ - クミネシ	1
62	08	83407-850-000	CONNECTING ROD, HORIZONTAL		オウエアク ヨコネ	1
63	08	83417-552-000	LIFTING LEVER LINK SPRING		ヒラネシ リンククワ - ハネ	1
64	08	B1183-850-000	RUBBER PLUG		オウエアク コムセン	1
65	08	83416-552-000	CONNECTING ROD HINGE SCREW		ヒラネシ ヨコネ - クミネシ	1

Note. (注記) 07. . . . . For MF-860, MF-870 MF-860, MF-870用  
 08. . . . . For MF-880, MF-890 MF-880, MF-890用  
 17. . . . . Special order part for thick thread & 2-thread 太ネ及び2本ネ用特別注文部品  
 (Spreading thread) (上ネリネ)

07. For MF-860, MF-870  
 08. For MF-880, MF-890  
 17. Special order part for thick thread & 2-thread (Spreading thread)  
 21. For MF-860, MF-870 (with finger guard)  
 22. For MF-870, MF-880, MF-890 (with finger guard)  
 23. Special order part for MF-860, MF-870 (with finger guard)  
 24. Special order part for MF-870, MF-880 (with finger guard)  
 25. Special order part for MF-880, MF-890 (with finger guard)  
 26. Special order part for MF-890, MF-890 (with finger guard)  
 27. This part is used when a blinder is mounted on the machine.



11. SPREADER & PRESSER FOOT LIFTER COMPONENTS  
 12. SILICONE OIL LUBRICANT UNIT & NEEDLE GUARD COMPONENTS  
 エスレン装置、針カバー関係

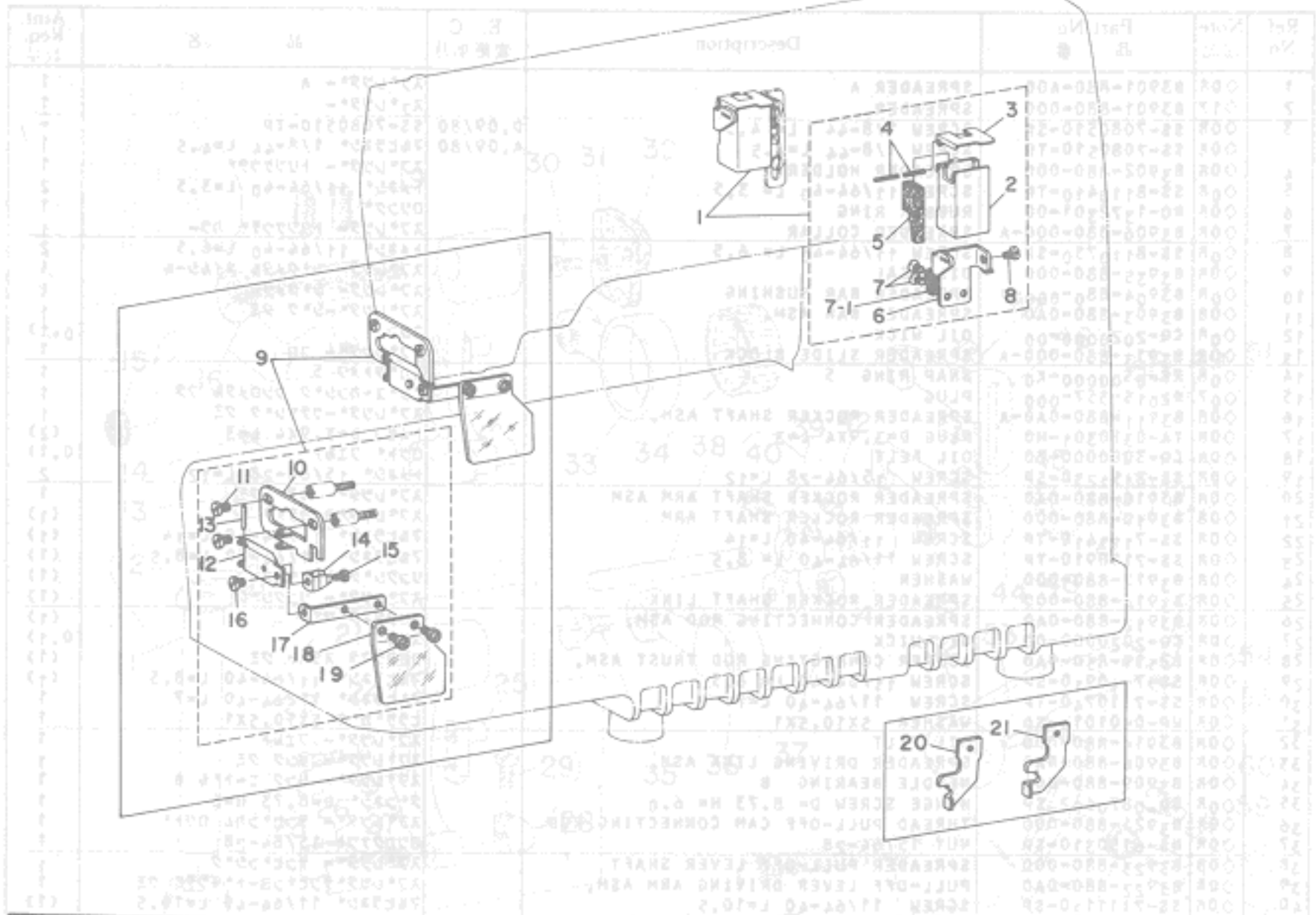

Ref. No.	Note	Part No.	Description	E. C.	品名	Amt. Req.
1		B9211-850-0A0	SILICONE OIL LUBRICANT UNIT		シリコンオイルユニット	1
2		B9211-850-000	SILICONE OIL TANK, UPPER		シリコンオイルタンク	(1)
3		B9213-850-000	SILICONE OIL TANK COVER, UPPER		シリコンオイルタンクカバー	(1)
4		PS-0170082-KH	SPRING PIN 1.7X0.8	0.02/80	PS-0150082-KH	-
5		PS-0150082-KH	SPRING PIN	A.02/80	スプリングピン	(2)
6		B9214-850-000	HEAT REMOVING FELT		ハイトレーシングフェルト	(1)
7		B9215-850-000	TANK SUPPORTING PLATE		シリコンオイルタンク支持板	(1)
7-1		SS-2090620-SP	SCREW 9/64-40 L=5.5		マルチラスシ 9/64-40 L=5.5	(2)
8		WP-0371026-SD	WASHER 3.7X7X1	A.11/79	ヒラカワシ 3.7X7X1	(2)
9	1R	SS-7110410-SP	SCREW 11/64-40 L=4		マルチラスシ 11/64-40 L=4	(1)
10	1R	B1144-850-0A0	NEEDLE GUARD ASM.		ハリカバーアッセンブリ	1
11	1R	B1144-850-000	NEEDLE GUARD		ハリカバー	(1)
12	1R	SS-7110510-SP	SCREW 11/64-40 L=5		マルチラスシ 11/64-40 L=5	(2)
13	1R	B1145-850-000	NEEDLE GUARD INSTALLING BASE		ハリカバー取り付けベース	(1)
14	1R	PS-0200142-K0	SPRING PIN 2.0X14		スプリングピン 2.0X14	(1)
15	1R	B1147-850-000	SPRING		ハリカバーバネ	(1)
16	1R	SS-7090410-SP	SCREW 9/64-40 L=3.5		マルチラスシ 9/64-40 L=3.5	(1)
17	1R	SS-7110510-SP	SCREW 11/64-40 L=5		マルチラスシ 11/64-40 L=5	(1)
18	1R	B1146-850-000	NEEDLE GUARD INSTALLING PLATE		ハリカバー取り付けプレート	(1)
19	1R	B1148-850-000	NEEDLE GUARD		ハリカバー	(1)
20	1R	SS-7110510-SP	SCREW 11/64-40 L=5		マルチラスシ 11/64-40 L=5	(2)
21	1R	B9101-860-800	TIMING GAUGE B		タイミングゲージ B	1
21	20	B9101-860-E00	TIMING GAUGE E		タイミングゲージ E	1

Note. (注記) 18. . . . . Accessory part  
 19. . . . . Accessory part for MF-860-EDM, MF-870-GDM, MF-880-EDM, MF-890-GDM  
 20. . . . . Accessory part for MF-860-EEM, MF-870-GEM, MF-880-EEM, MF-890-GEM

13. EXCLUSIVE PARTS FOR MF-860-EEM, MF-870-GEM, MF-880-EEM, MF-890-GEM  
MF-860-EEM、MF-870-GEM、MF-880-EEM、MF-890-GEM専用部品

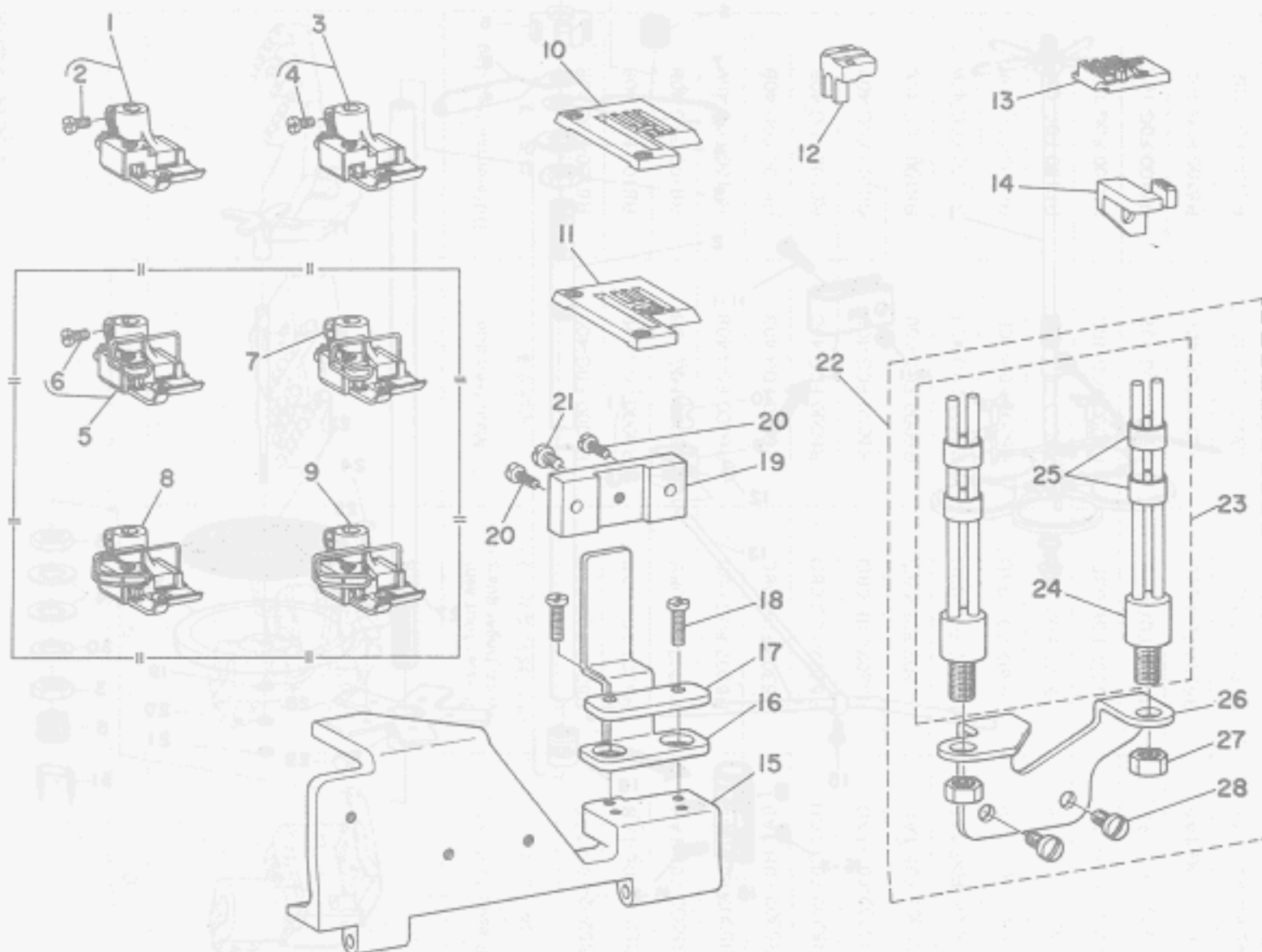

Ref. No.	Note 注記	Part No. 品番	Description	E. C. 変更年月	品名	Amt. Req. 数量
1	◇21	R5202-FOE-1AE	PRESSER FOOT ASM. (EE)		オグイ クミ	1
2		SS-6090670-TP	SCREW 9/64-40 L=6		ヒラネシ* 9/64-40 L=6	(1)
3	◇22	R5302-FOG-1AE	PRESSER FOOT ASM. (GE)		オグイ クミ	1
4		SS-6090670-TP	SCREW 9/64-40 L=6		ヒラネシ* 9/64-40 L=6	(1)
5	◇23	R5202-FOE-0BE	PRESSER FOOT ASM. (EE)		オグイ クミ	1
6		SS-6090670-TP	SCREW 9/64-40 L=6		ヒラネシ* 9/64-40 L=6	(1)
7	◇24	R5302-FOG-0BE	PRESSER FOOT ASM. (GE)		オグイ クミ	1
8	◇25	R5202-FOE-1BE	PRESSER FOOT ASM. (EE)		オグイ クミ	1
9	◇26	R5302-FOG-1BE	PRESSER FOOT ASM. (GE)		オグイ クミ	1
10	◇21	R4254-FOE-GOE	THROAT PLATE (EGE)		ハリイタ	1
11	◇22	R4354-FOG-GOE	THROAT PLATE (GGE)		ハリイタ	1
12		B1623-850-00E	FEED DOG HOLDER E		オクリハ* トリツケタイ E	1
13		R6000-FOG-40E	MAIN FEED DOG (GE)		シメ オクリハ* GE	1
14		R6100-FOG-10E	DIFFERENTIAL FEED DOG (GE)		フク オクリハ* GE	1
15		B1117-850-000	LOOPER COVER		ル=ハ* カハ= B	1
16		B5004-860-000-A	BINDER HOLDING BASE		ハ* インタ= シシ* タイ	1
17		B5005-860-000	BINDER HOLDING BASE WASHER		ハ* インタ= シシ* タイ* イ* カ* ネ	1
18		SS-7111410-SP	SCREW 11/64-40 L=14		マルヒラネシ* 11/64-40 L=14	2
19	◇27	B5006-860-000	HOLDER GUIDING PLATE		ハ* インタ= シシ* アン* アイ* タ	1
20	◇27	SS-7110910-SP	SCREW 11/64-40 L= 8,5		マルヒラネシ* 11/64-40 L= 8,5	2
21	◇27	SS-7120640-SP	SCREW 3/16-28 L=6		マルヒラネシ* 3/16-28 L= 6	1
22	◇27	B5001-860-0C0	GUIDE BAR ASM.		アン* アイ* ネ= クミ	1
23	◇27	B5001-860-0B0	GUIDE BAR ASM.		アン* アイ* ネ= クミ	(1)
24	◇27	B5001-860-0A0	GUIDE BAR ASM.		アン* アイ* ネ= クミ	(1)
25	◇27	BP-8000000-00	VINYL TUBE, WHITE D=8		ビ* ニ* ール ハ* イ* F* 8	(0,1)
26	◇27	B5003-860-000	GUIDE BAR INSTALLING BASE		アン* アイ* ネ= トリツケタイ	(1)
27	◇27	NS-6740510-SP	NUT 3/8-28		6カク* ナツト 3/8-28	(2)
28	◇27	SS-7150740-SP	SCREW 15/64-28 L=7		マルヒラネシ* 15/64-28 L= 7	(2)

Note. (注記) ◇21. . . . . For MF-860-EEM, MF-880-EEM MF-860-EEM, MF-880-EEM 用  
 ◇22. . . . . For MF-870-GEM, MF-890-GEM MF-870-GEM, MF-890-GEM 用  
 ◇23. . . . . Special order part for MF-860-EEM (With finger guard) MF-860-EEM 用特別注文部品 (指ガード付)  
 ◇24. . . . . Special order part for MF-870-GEM (With finger guard) MF-870-GEM 用特別注文部品 (指ガード付)  
 ◇25. . . . . Special order part for MF-880-EEM (With finger guard) MF-880-EEM 用特別注文部品 (指ガード付)  
 ◇26. . . . . Special order part for MF-890-GEM (With finger guard) MF-890-GEM 用特別注文部品 (指ガード付)  
 ◇27. . . . . This part is used when a Binder is mounted on the machine. この部品は、バインダー付きミシンに使用します。

# 14. THREAD STAND COMPONENTS

糸立装置関係

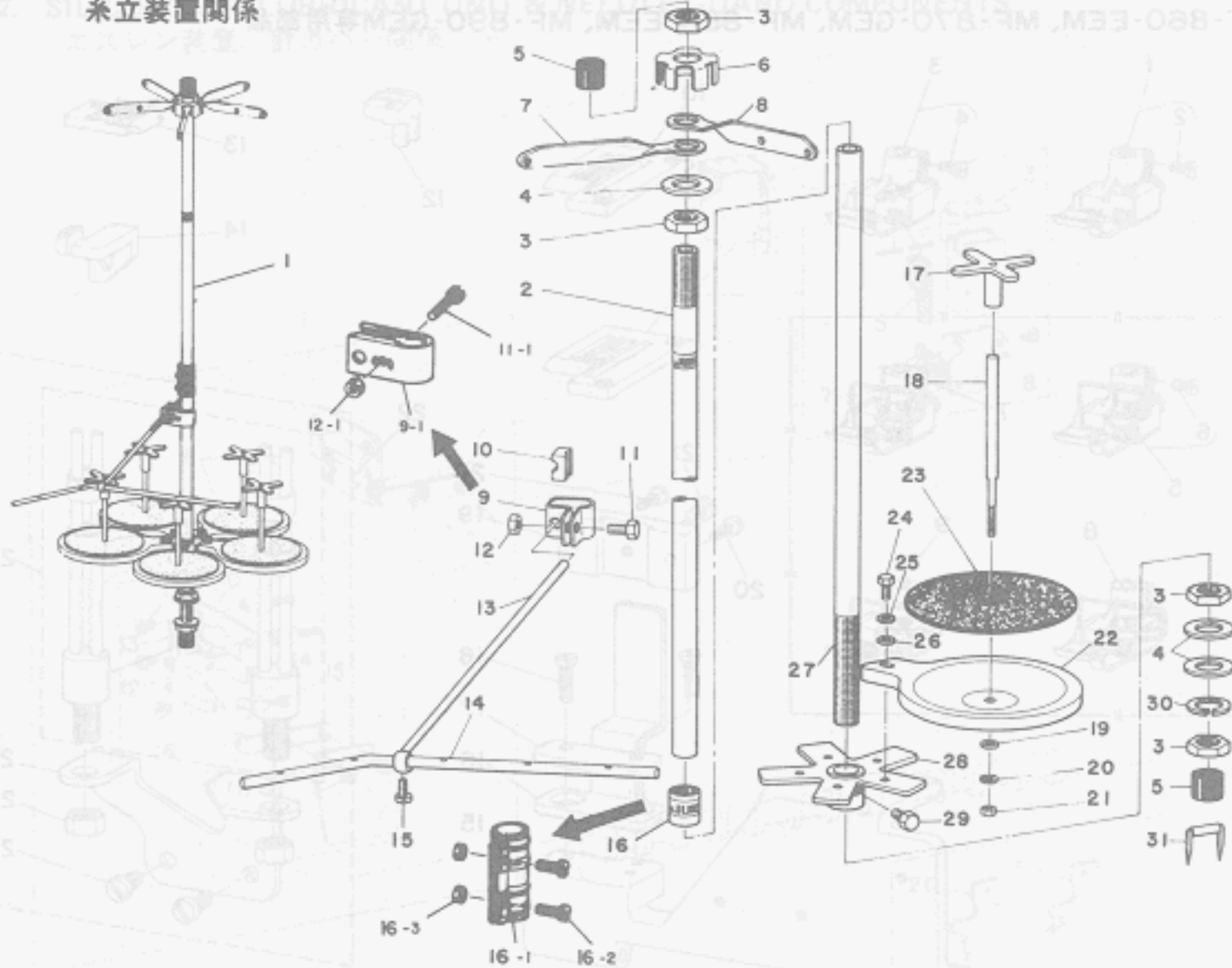

Ref. No.	Note 注記	Part No. 品番	Description	E. C. 変更年月	品名	Amt. Req. 数量
1		B3301-704-0A0	THREAD STAND ASM.		イトダテソチ クミ	1
2		B3313-704-000	SPOOL REST ROD, UPPER	D.02/80	イトダテソチ - クミ	-
		B3313-704-0A0	SPOOL REST ROD ASM, UPPER	A.02/80	イトダテソチ - クミ クミ	(1)
3		NH-6160511-SE	NUT M16X1.5		6カクナツト M16X1.5 152	(4)
4		WP-1702600-S0	WASHER 17X30X2.6		ヒラシカネ 17X30X2.6	(3)
5		B3311-704-000	SPOOL REST ROD RUBBER CAP		イトダテソチ - ココロ	(2)
6		B3306-704-000	THREAD GUIDE STOPPER PLATE		イトダテ イトダテイ トメイ	(1)
7		B3307-704-000	THREAD GUIDE A		イトダテ イトダテイ A	(3)
8		B3308-704-000	THREAD GUIDE B		イトダテ イトダテイ B	(2)
9		B3304-704-000	THREAD GUIDE ARM HOLDER	D.02/80	イトダテ イトダテイウチ ネジ	-
9-1		B3304-704-000-A	THREAD GUIDE ARM HOLDER	A.02/80	イトダテイウチ ネジ	(1)
10		B3310-704-000	BLOCK	D.02/80	イトダテイ ネジ - コマ	-
11		SM-9061203-SE	SCREW M6 L=12	D.02/80	6カクネネ M6 L=12	-
11-1		SM-6052700-SC	SCREW M5 L=27	A.02/80	ヒラシカネ M5X0.8 L=27	(1)
12		NH-6060003-SC	NUT M6	D.02/80	6カクナツト M 6X1.0 352	-
12-1		NH-6050000-SC	NUT M5	A.02/80	6カクナツト	(1)
13		B3309-704-000	THREAD GUIDE ARM		イトダテ イトダテイ ウチ	(1)
14		B3311-804-000	LOWER THREAD GUIDE		イトダテ イトダテイ シタ	(1)
15		SS-7110540-SP	SCREW 11/64-40 L=5		マヒラシカネ 11/64-40 L=5	(1)
16		B3305-704-0A0	SPOOL REST ROD JOINT ASM.	D.02/80	イトダテソチ - ツキツク クミ	-
16-1		B3305-704-000-A	SPOOL REST ROD JOINT	A.02/80	イトダテソチ - ツキツク	(1)
16-2		SM-6041410-SC	SCREW M4X0.7 L=14	A.02/80	ヒラシカネ M4X0.7 L=14	(2)
16-3		NH-6040000-SN	NUT M4	A.02/80	6カクナツト M 4X0.7	(2)
17		B3312-012-000	SPOOL VIBRATION STOPPER		イトダテ フレトメ	(5)
18		B3307-804-000	SPOOL PIN		イトダテ ウチ	(5)
19		WP-0560860-SE	WASHER 5.6X12X0.8		ヒラシカネ 5.6X12X0.8	(5)
20		WS-0521010-KN	SPRING WASHER 5.2X8.2X1		ハネシカネ 5.2X8.2X1	(5)
21		NS-6120310-SN	NUT 3/16-28		6カクナツト 3/16-28	(5)
22		B3303-704-000	SPOOL REST		イトダテ ウチ	(5)
23		B3311-012-000	SPOOL REST CUSHION		イトダテ ウチ	(5)
24		SM-9050813-SE	SCREW M5X0.8 L=8		6カクネネ M5X0.8 L=8	(5)
25		WS-0521010-KN	SPRING WASHER 5.2X8.2X1		ハネシカネ 5.2X8.2X1	(5)
26		WP-0520656-SA	WASHER 5.2X9.5X0.6		ヒラシカネ 5.2X9.5X0.6	(5)
27		B3301-704-000	SPOOL REST ROD, LOWER	D.02/80	イトダテソチ - シタ	-
		B3301-704-000-A	SPOOL REST ROD, LOWER	A.02/80	イトダテソチ - シタ	(1)
28		B3302-704-000	SPOOL REST BRACKET		イトダテ ウチ	(1)
29		SM-9061080-SE	SCREW M6 L=10		6カクネネ M6 L=10	(1)
30		WS-1643202-KR	SPRING WASHER 16.4X26.6X3.2		ハネシカネ 16.4X26.6X3.2	(1)
31		MA0-11532000	STAPLE		コート スチツク	(3)

15. TABLE OF EXCHANGING PARTS

Model 機種名	Needle gauge (mm/m) 針 幅	A	B	C	D	E	F
(1) MF-860							
		Throat plate 針 板	Needle clamp asm. 針 留(組)	Presser foot asm. 押 エ(組)	Presser foot asm. (with finger guard) 押エ(組)(指ガード付)	Main feed dog 主送り歯	Differential feed dog 副送り歯
1 MF-860-DBM	3.2 (1/8")	R4254-F0D-G0B	B1409-860-DA0	R5202-F0D-1AB	R5202-F0D-0BB	R6000-F0G-40B	R6100-F0G-40B
2 MF-860-EBM	4 (5/32")	R4254-F0E-G0B	B1409-860-EA0	R5202-F0E-1AB	R5202-F0E-0BB	R6000-F0G-40B	R6100-F0G-40B
3 MF-860-FBM	4.8 (3/16")	R4254-F0F-G0B	B1409-860-FA0	R5302-F0F-1AB	R5302-F0F-0BB	R6000-F0G-40B	R6100-F0G-40B
4 MF-860-GBM	5.6 (7/32")	R4254-F0G-G0B	B1409-860-GA0	R5302-F0G-1AB	R5302-F0G-0BB	R6000-F0G-40B	R6100-F0G-40B
5 MF-860-HBM	6.4 (1/4")	R4254-F0H-G0B	B1409-860-HA0	R5302-F0H-1AB	R5302-F0H-0BB	R6000-F0H-40B	R6100-F0H-40B
6 MF-860-DDM	3.2 (1/8")	R4254-F0D-G0B	B1409-860-DA0	R5202-F0D-1AD	R5202-F0D-0BD	R6000-F0G-40B	R6100-F0G-40B
7 MF-860-EDM	4 (5/32")	R4254-F0E-G0B	B1409-860-EA0	R5202-F0E-1AD	R5202-F0E-0BD	R6000-F0G-40B	R6100-F0G-40B
8 MF-860-FDM	4.8 (3/16")	R4254-F0F-G0B	B1409-860-FA0	R5302-F0F-1AD	R5302-F0F-0BD	R6000-F0G-40B	R6100-F0G-40B
9 MF-860-GDM	5.6 (7/32")	R4254-F0G-G0B	B1409-860-GA0	R5302-F0G-1AD	R5302-F0G-0BD	R6000-F0G-40B	R6100-F0G-40B
10 MF-860-HDM	6.4 (1/4")	R4254-F0H-G0B	B1409-860-HA0	R5302-F0H-1AD	R5302-F0H-0BD	R6000-F0H-40B	R6100-F0H-40B
11 MF-860-DEM	3.2 (1/8")	R4254-F0D-G0E	B1409-860-DA0	R5202-F0D-1AE	R5202-F0D-0BE	R6000-F0G-10E	R6100-F0G-10E
12 MF-860-DEM	4 (5/32")	R4254-F0E-G0E	B1409-860-EA0	R5202-F0E-1AE	R5202-F0E-0BE	R6000-F0G-10E	R6100-F0G-10E
13 MF-860-FEM	4.8 (3/16")	R4254-F0F-G0E	B1409-860-FA0	R5302-F0F-1AE	R5302-F0F-0BE	R6000-F0G-10E	R6100-F0G-10E
14 MF-860-GEM	5.6 (7/32")	R4254-F0G-G0E	B1409-860-GA0	R5302-F0G-1AE	R5302-F0G-0BE	R6000-F0G-10E	R6100-F0G-10E
15 MF-860-HEM	6.4 (1/4")	R4254-F0H-G0E	B1409-860-HA0	R5302-F0H-1AE	R5302-F0H-0BE	R6000-F0H-40E	R6100-F0H-40E



交換部品表

MF880-DBM-40E  
MF880-F0G-40E  
MF880-F0H-40E

MF880-F0D-1BB  
MF880-F0E-1BB  
MF880-F0F-1BB

MF880-F0G-1BB  
MF880-F0H-1BB  
MF880-F0I-1BB

MF880-F0J-1BB  
MF880-F0K-1BB  
MF880-F0L-1BB

MF880-F0M-1BB  
MF880-F0N-1BB  
MF880-F0O-1BB





MF880-F0P-1BB  
MF880-F0Q-1BB  
MF880-F0R-1BB

MF880-F0S-1BB  
MF880-F0T-1BB  
MF880-F0U-1BB

MF880-F0V-1BB  
MF880-F0W-1BB  
MF880-F0X-1BB

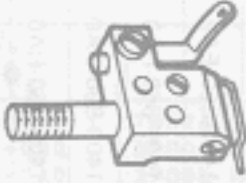
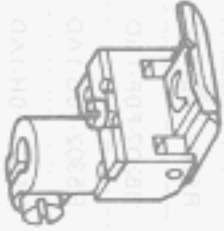





15. TABLE OF EXCHANGING PARTS

(2) MF-880

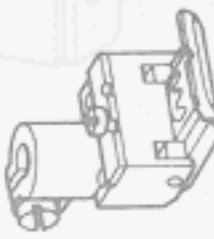

Model 機種名	Needle gauge (m/m) 針 幅	A 	B 	C 	D 	E 	F 
	針 幅	針 板	Needle clamp asm. 針 留(組)	Presser foot asm. 押 工(組)	Presser foot asm. (with finger guard) 押工(組)(指ガード付)	Main feed dog 主送り歯	Differential feed dog 副送り歯
1 MF-880-DBM	3.2 (1/8")	R4254-F0D-G0B	B1409-880-DA0	R5202-F0D-1AB	R5202-F0D-1BB	R6000-F0G-40B	R6100-F0G-40B
2 MF-880-EBM	4 (5/32")	R4254-F0E-G0B	B1409-880-EA0	R5202-F0E-1AB	R5202-F0E-1BB	R6000-F0G-40B	R6100-F0G-40B
3 MF-880-FBM	4.8 (3/16")	R4254-F0F-G0B	B1409-880-FA0	R5302-F0F-1AB	R5302-F0F-1BB	R6000-F0G-40B	R6100-F0G-40B
4 MF-880-GBM	5.6 (7/32")	R4254-F0G-G0B	B1409-880-GA0	R5302-F0G-1AB	R5302-F0G-1BB	F6000-F0G-40B	R6100-F0G-40B
5 MF-880-HBM	6.4 (1/4")	R4254-F0H-G0B	B1409-880-HA0	R5302-F0H-1AB	R5302-F0H-1BB	R6000-F0H-40B	R6100-F0H-40B
6 MF-880-DDM	3.2 (1/8")	R4254-F0D-G0B	B1409-880-DA0	R5202-F0D-1AD	R5202-F0D-1BD	R6000-F0G-40B	R6100-F0G-40B
7 MF-880-EDM	4 (5/32")	R4254-F0E-G0B	B1409-880-EA0	R5202-F0E-1AD	R5202-F0E-1BD	R6000-F0G-40B	R6100-F0G-40B
8 MF-880-FDM	4.8 (3/16")	R4254-F0F-G0B	B1409-880-FA0	R5302-F0F-1AD	R5302-F0F-1BD	R6000-F0G-40B	R6100-F0G-40B
9 MF-880-GDM	5.6 (7/32")	R4254-F0G-G0B	B1409-880-GA0	R5302-F0G-1AD	R5302-F0G-1BD	R6000-F0G-40B	R6100-F0G-40B
10 MF-880-HDM	6.4 (1/4")	R4254-F0H-G0B	B1409-880-HA0	R5302-F0H-1AD	R5302-F0H-1BD	R6000-F0H-40B	R6100-F0H-40B
11 MF-880-DEM	3.2 (1/8")	R4254-F0D-G0E	B1409-880-DA0	R5202-F0D-1AE	R5202-F0D-1BE	R6000-F0G-40E	R6100-F0G-10E
12 MF-880-EEM	4 (5/32")	R4254-F0E-G0E	B1409-880-EA0	R5202-F0E-1AE	R5202-F0E-1BE	R6000-F0G-40E	R6100-F0G-10E
13 MF-880-FEM	4.8 (3/16")	R4254-F0F-G0E	B1409-880-FA0	R5302-F0F-1AE	R5302-F0F-1BE	R6000-F0G-40E	R6100-F0G-10E
14 MF-880-GEM	5.6 (7/32")	R4254-F0G-G0E	B1409-880-GA0	R5302-F0G-1AE	R5302-F0G-1BE	R6000-F0G-40E	R6100-F0G-10E
15 MF-880-HEM	6.4 (1/4")	R4254-F0H-G0E	B1409-880-HA0	R5302-F0H-1AE	R5302-F0H-1BE	R6000-F0H-40E	R6100-F0H-10E

15. TABLE OF EXCHANGING PARTS  
(3) MF-870

交換部品表

Model 機種名	Needle gauge (m/m) 針 幅	A 	B 	C 	D 	E 	F 
	Needle gauge (m/m) 針 幅	Throat plate 針 板	Needle clamp asm. 針 留(組)	Presser foot asm. 押 子(組)	Presser foot asm. (with finger guard) 押子(組)(指ガード付)	Main feed dog 主送り歯	Differential feed dog 副送り歯
1 MF-870-FBM	4.8 (3/16")	R4352-F0F-G0B	B1409-870-FA0	R5302-F0F-1AB	R5302-F0F-0BB	R6000-F0G-40B	R6100-F0G-40B
2 MF-870-G8M	5.6 (7/32")	R4352-F0G-G0B	B1409-870-GA0	R5302-F0G-1AB	R5302-F0G-0BB	R6000-F0G-40B	R6100-F0G-40B
3 MF-870-H8M	6.4 (1/4")	R4354-F0H-G0B	B1409-870-HA0	R5302-F0H-1AB	R5302-F0H-0BB	R6000-F0H-40B	R6100-F0H-40B
4 MF-870-FDM	4.8 (3/16")	R4352-F0F-G0B	B1409-870-FA0	R5302-F0F-1AD	R5302-F0F-0BD	R6000-F0G-40B	R6100-F0G-40B
5 MF-870-GDM	5.6 (7/32")	R4352-F0G-G0B	B1409-870-GA0	R5302-F0G-1AD	R5302-F0G-0BD	R6000-F0G-40B	R6100-F0G-40B
6 MF-870-HDM	6.4 (1/4")	R4354-F0H-G0B	B1409-870-HA0	R5302-F0H-1AD	R5302-F0H-0BD	R6000-F0H-40B	R6100-F0H-40B
7 MF-870-FEM	4.8 (3/16")	R4352-F0F-G0E	B1409-870-FA0	R5302-F0F-1AE	R5302-F0F-0BE	R6000-F0G-10E	R6100-F0G-10E
8 MF-870-GEM	5.6 (7/32")	R4352-F0G-G0E	B1409-870-GA0	R5302-F0G-1AE	R5302-F0G-0BE	R6000-F0G-40E	R6100-F0G-10E
9 MF-870-HEM	6.4 (1/4")	R4354-F0H-G0E	B1409-870-HA0	R5302-F0H-1AE	R5302-F0H-0BE	R6000-F0H-40E	R6100-F0H-10E

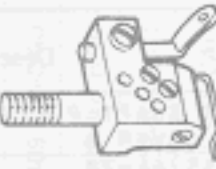
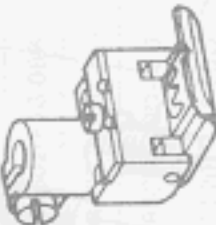
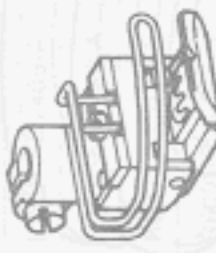
(4) MF-890

Model 機種名	Needle gauge (m/m) 針 幅	A 	B 	C 	D 	E 	F 
	Needle gauge (m/m) 針 幅	Throat plate 針 板	Needle clamp asm. 針 留(組)	Presser foot asm. 押 子(組)	Presser foot asm. (with finger guard) 押子(組)(指ガード付)	Main feed dog 主送り歯	Differential feed dog 副送り歯
1 MF-890-FBM	4.8 (3/16")	R4352-F0F-G0B	B1409-890-FA0	R5302-F0F-1AB	R5302-F0F-1BB	R6000-F0G-40B	R6100-F0G-40B
2 MF-890-G8M	5.6 (7/32")	R4352-F0G-G0B	B1409-890-GA0	R5302-F0G-1AB	R5302-F0G-1BB	R6000-F0G-40B	R6100-F0G-40B
3 MF-890-H8M	6.4 (1/4")	R4354-F0H-G0B	B1409-890-HA0	R5302-F0H-1AB	R5302-F0H-1BB	R6000-F0H-40B	R6100-F0H-40B
4 MF-890-FDM	4.8 (3/16")	R4352-F0F-G0B	B1409-890-FA0	R5302-F0F-1AD	R5302-F0F-1BD	R6000-F0G-40B	R6100-F0G-40B
5 MF-890-GDM	5.6 (7/32")	R4352-F0G-G0B	B1409-890-GA0	R5302-F0G-1AD	R5302-F0G-1BD	R6000-F0G-40B	R6100-F0G-40B
6 MF-890-HDM	6.4 (1/4")	R4354-F0H-G0B	B1409-890-HA0	R5302-F0H-1AD	R5302-F0H-1BD	R6000-F0H-40B	R6100-F0H-40B
7 MF-890-FEM	4.8 (3/16")	R4352-F0F-G0E	B1409-890-FA0	R5302-F0F-1AE	R5302-F0F-1BE	R6000-F0G-40E	R6100-F0G-10E
8 MF-890-GEM	5.6 (7/32")	R4352-F0G-G0E	B1409-890-GA0	R5302-F0G-1AE	R5302-F0G-1BE	R6000-F0G-40E	R6100-F0G-10E
9 MF-890-HEM	6.4 (1/4")	R4354-F0H-G0E	B1409-890-HA0	R5302-F0H-1AE	R5302-F0H-1BE	R6000-F0H-40E	R6100-F0H-10E

16. SPECIAL PARTS FOR WESTERN EUROPE

ヨーロッパ用部品

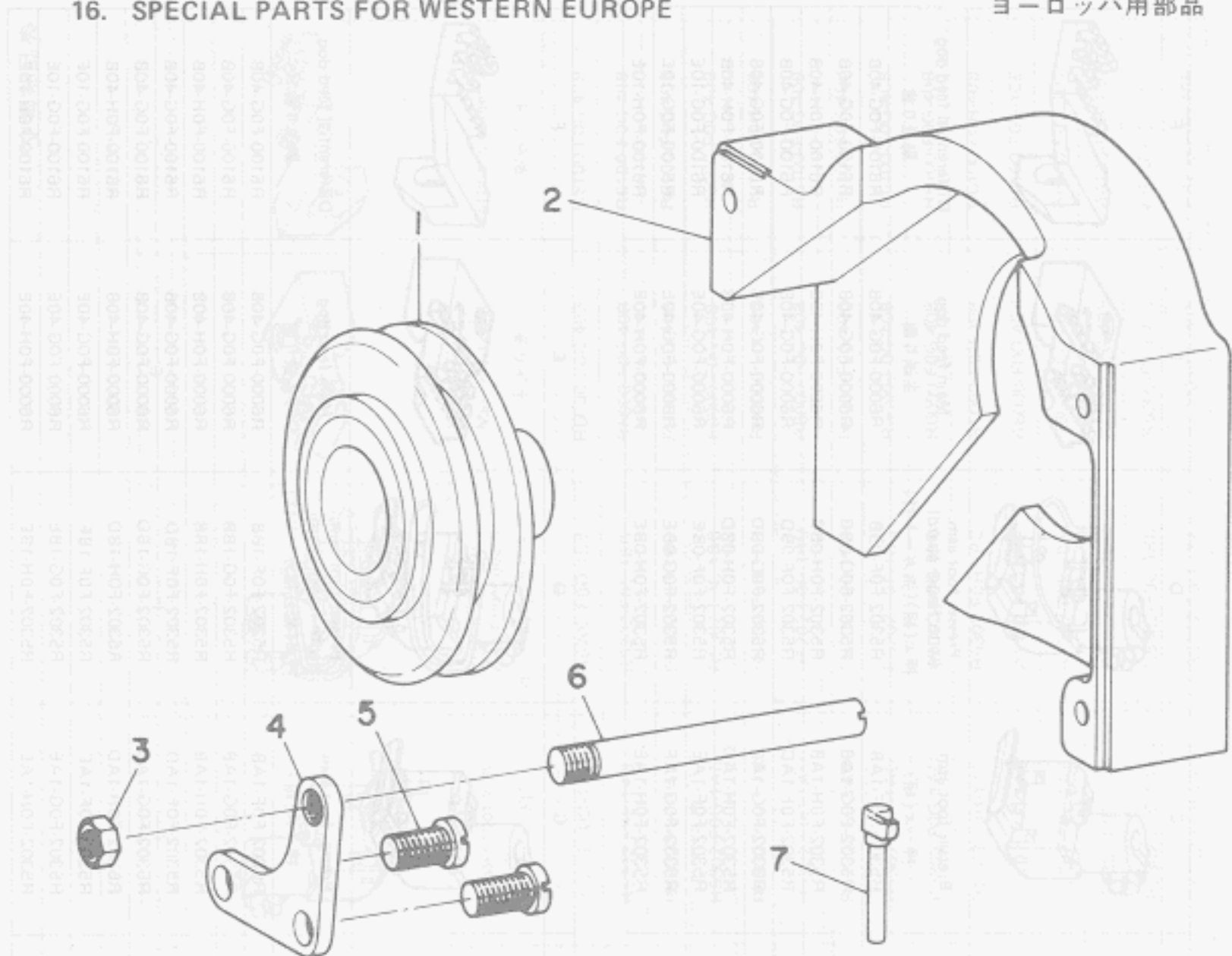





Ref. No.	Note 注記	Part No. 品番	Description	E. C. 変更年月	品名	Amt. Req. 個数
1		B1806-850-A00	LOWER SHAFT PULLEY		シフトシク ハスミクワム	1
2		B1139-850-A00	BELT COVER B		ベルトカバー B	1
3	◇18	NS-6150320-SP	NUT 15/64-28		6カクナツト 15/64-28	1
4	◇18	B1811-850-000	SYNCHRONIZER RETAINING BOLT PLATE		シンクロアイワートメシクワ	1
5	◇18	SS-7151210-SP	SCREW 15/64-28 L=12.0		マルチワネジ 15/64-28 L=12	2
6	◇18	B1810-850-000	SYNCHRONIZER RETAINING BOLT		シンクロアイワートメシク	1
7	◇18	B1175-860-000	RIGHT THREAD GUARD		ミキイタク	1
Note.(注記)		◇18. . . . .	Accessory part		付属品	

17. TABLE OF EXCHANGING PARTS FOR WESTERN EUROPE

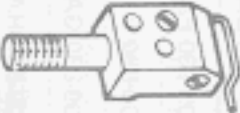
(1) MF-860

ヨーロッパ用交換部品表







	A	B	C	D	E	F
						
	Throat plate 針板	Needle clamp asm. 針留(組)	Presser foot asm. (with finger guard) 押エ(組)(指ガード付)	Main feed dog 主送り歯	Differential feed dog 副送り歯	Feed dog holder 送り歯取付台
1	Needle gauge (mm/m) 針幅 3.2 (1/8")	R4261-F0D-F0B	R5202-F0D-08B	R6001-F0S-40B-A	R6101-F0S-40B	B1623-850-00A
2	4 (5/32")	R4261-F0E-F0B	R5202-F0E-08B	R6001-F0S-40B-A	R6101-F0S-40B	B1623-850-00A
3	4.8 (3/16")	R4261-F0F-F0B	R5302-F0F-08B	R6001-F0S-40B-A	R6101-F0S-40B	B1623-850-00A
4	5.6 (7/32")	R4261-F0G-F0B	R5302-F0G-08B	R6001-F0S-40B-A	R6101-F0S-40B	B1623-850-00A
5	6.4 (1/4")	R4261-F0H-F0B	R5302-F0H-08B	R6001-F0H-40B-A	R6101-F0H-40B	B1623-850-00A
6	3.2 (1/8")	R4261-F0D-F0B	R5201-F0D-08D	R6001-F0S-40B-A	R6101-F0S-40B	B1623-850-00A
7	4 (5/32")	R4261-F0E-F0B	R5201-F0E-08D	R6001-F0S-40B-A	R6101-F0S-40B	B1623-850-00A
8	4.8 (3/16")	R4261-F0F-F0B	R5301-F0F-08D	R6001-F0S-40B-A	R6101-F0S-40B	B1623-850-00A
9	5.6 (7/32")	R4261-F0G-F0B	R5301-F0G-08D	R6001-F0S-40B-A	R6101-F0S-40B	B1623-850-00A
10	6.4 (1/4")	R4261-F0H-F0B	R5301-F0H-08D	R6001-F0H-40B-A	R6101-F0H-40B	B1623-850-00A
11	3.2 (1/8")	R4261-F0D-H0E	R5201-F0D-08E	R6001-F0S-30E	R6101-F0S-10E	B1623-850-00U
12	4 (5/32")	R4261-F0E-H0E	R5201-F0E-08E	R6001-F0S-30E	R6101-F0S-10E	B1623-850-00U
13	4.8 (3/16")	R4261-F0F-H0E	R5301-F0F-08E	R6001-F0S-30E	R6101-F0S-10E	B1623-850-00U
14	5.6 (7/32")	R4261-F0G-H0E	R5301-F0G-08E	R6001-F0S-30E	R6101-F0S-10E	B1623-850-00U
15	6.4 (1/4")	R4261-F0H-H0E	R5301-F0H-08E	R6001-F0H-30E	R6101-F0H-10E	B1623-850-00U



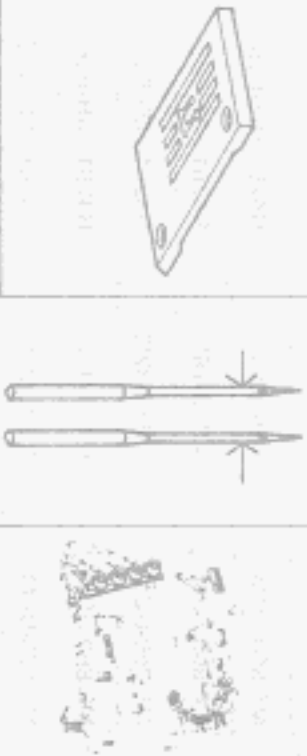

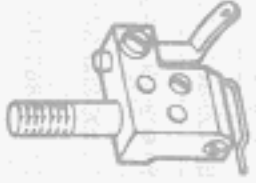
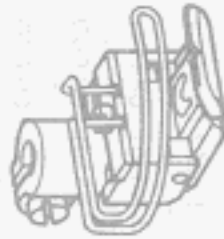



17. TABLE OF EXCHANGING PARTS FOR WESTERN EUROPE

(2) MF-880





ヨーロッパ用交換部品表

	A	B	C	D	E	F
						
Model 機種名	Throat plate 針板	Needle clamp asm. 針留(組)	Presser foot asm. (with finger guard) 押エ(組)(指ガード付)	Main feed dog 主送り歯	Differential feed dog 副送り歯	Feed dog holder 送り歯取付台
Needle gauge (mm/m)	針幅					
1 MF-880-DBM	R4261-F0D-F0B	B1409-880-DA0	R5202-F0D-1BB	R6001-F0S-40B-A	R6101-F0S-40B	B1623-850-00A
2 MF-880-EBM	R4261-F0E-F0B	B1409-880-EA0	R5202-F0E-1BB	R6001-F0S-40B-A	R6101-F0S-40B	B1623-850-00A
3 MF-880-FBM	R4261-F0F-F0B	B1409-880-FA0	R5302-F0F-1BB	R6001-F0S-40B-A	R6101-F0S-40B	B1623-850-00A
4 MF-880-GBM	R4261-F0G-F0B	B1409-880-GA0	R5302-F0G-1BB	R6001-F0S-40B-A	R6101-F0S-40B	B1623-850-00A
5 MF-880-HBM	R4261-F0H-F0B	B1409-880-HA0	R5302-F0H-1BB	R6001-F0H-40B-A	R6101-F0H-40B	B1623-850-00A
6 MF-880-DDM	R4261-F0D-F0B	B1409-880-DA0	R5201-F0D-1BD	R6001-F0S-40B-A	R6101-F0S-40B	B1623-850-00A
7 MF-880-EDM	R4261-F0E-F0B	B1409-880-EA0	R5201-F0E-1BD	R6001-F0S-40B-A	R6101-F0S-40B	B1623-850-00A
8 MF-880-FDM	R4261-F0F-F0B	B1409-880-FA0	R5301-F0F-1BD	R6001-F0S-40B-A	R6101-F0S-40B	B1623-850-00A
9 MF-880-GDM	R4261-F0G-F0B	B1409-880-GA0	R5301-F0G-1BD	R6001-F0S-40B-A	R6101-F0S-40B	B1623-850-00A
10 MF-880-HDM	R4261-F0H-F0B	B1409-880-HA0	R5301-F0H-1BD	R6001-F0H-40B-A	R6101-F0H-40B	B1623-850-00A
11 MF-880-DEM	R4261-F0D-H0E	B1409-880-DA0	R5202-F0D-1BE	R6001-F0S-30E	R6101-F0S-10E	B1623-850-00U
12 MF-880-EEM	R4261-F0E-H0E	B1409-880-EA0	R5202-F0E-1BE	R6001-F0S-30E	R6101-F0S-10E	B1623-850-00U
13 MF-880-FEM	R4261-F0F-H0E	B1409-880-FA0	R5302-F0F-1BE	R6001-F0S-30E	R6101-F0S-10E	B1623-850-00U
14 MF-880-GEM	R4261-F0G-H0E	B1409-880-GA0	R5302-F0G-1BE	R6001-F0S-30E	R6101-F0S-10E	B1623-850-00U
15 MF-880-HEM	R4261-F0H-H0E	B1409-880-HA0	R5302-F0H-1BE	R6001-F0H-30E	R6101-F0H-10E	B1623-850-00U

ヨーロッパ用交換部品表  
17. TABLE OF EXCHANGING PARTS FOR WESTERN EUROPE  
(3) MF-870

Model 機種名	Needle gauge (m/m) 針 幅	A 	B 	C 	D 	E 	F 
Model 機種名	Needle gauge (m/m) 針 幅	Throat plate 針 板	Needle clamp asm. 針 留(組)	Presser foot asm. (with finger guard) 押エ(組)(指ガード付)	Main feed dog 主送り歯	Differential feed dog 副送り歯	Feed dog holder 送り歯取付台
1 MF-870-FBM	4.8 (3/16")	R4361-F0F-F0B	B1409-870-FA0	R5302-F0F-0BB	R6001-F0S-40B-A	R6101-F0S-40B	B1623-850-00A
2 MF-870-GBM	5.6 (7/32")	R4361-F0G-F0B	B1409-870-GA0	R5302-F0G-0BB	R6001-F0S-40B-A	R6101-F0S-40B	B1623-850-00A
3 MF-870-HBM	6.4 (1/4")	R4361-F0H-F0B	B1409-870-HA0	R5302-F0H-0BB	R6001-F0H-40B-A	R6101-F0H-40B	B1623-850-00A
4 MF-870-FDM	4.8 (3/16")	R4361-F0F-F0B	B1409-870-FA0	R5301-F0F-0BD	R6001-F0S-40B-A	R6101-F0S-40B	B1623-850-00A
5 MF-870-GDM	5.6 (7/32")	R4361-F0G-F0B	B1409-870-GA0	R5301-F0G-0BD	R6001-F0S-40B-A	R6101-F0S-40B	B1623-850-00A
6 MF-870-HDM	6.4 (1/4")	R4361-F0H-F0B	B1409-870-HA0	R5301-F0H-0BD	R6001-F0H-40B-A	R6101-F0H-40B	B1623-850-00A
7 MF-870-FEM	4.8 (3/16")	R4361-F0F-H0E	B1409-870-FA0	R5301-F0F-0BE	R6001-F0S-30E	R6101-F0S-10E	B1623-850-00U
8 MF-870-GEM	5.6 (7/32")	R4361-F0G-H0E	B1409-870-GA0	R5301-F0G-0BE	R6001-F0S-30E	R6101-F0S-10E	B1623-850-00U
9 MF-870-HEM	6.4 (1/4")	R4361-F0H-H0E	B1409-870-HA0	R5301-F0H-0BE	R6001-F0H-30E	R6101-F0H-10E	B1623-850-00U

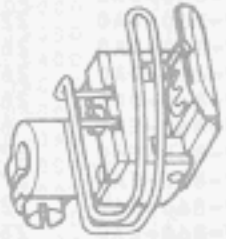
(4) MF-890

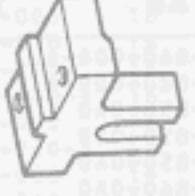
Model 機種名	Needle gauge (m/m) 針 幅	A 	B 	C 	D 	E 	F 
Model 機種名	Needle gauge (m/m) 針 幅	Throat plate 針 板	Needle clamp asm. 針 留(組)	Presser foot asm. (with finger guard) 押エ(組)(指ガード付)	Main feed dog 主送り歯	Differential feed dog 副送り歯	Feed dog holder 送り歯取付台
1 MF-890-FBM	4.8 (3/16")	R4361-F0F-F0B	B1409-890-FA0	R5302-F0F-1BB	R6001-F0S-40B-A	R6101-F0S-40B	B1623-850-00A
2 MF-890-GBM	5.6 (7/32")	R4361-F0G-F0B	B1409-890-GA0	R5302-F0G-1BB	R6001-F0S-40B-A	R6101-F0S-40B	B1623-850-00A
3 MF-890-HBM	6.4 (1/4")	R4361-F0H-F0B	B1409-890-HA0	R5302-F0H-1BB	R6001-F0H-40B-A	R6101-F0H-40B	B1623-850-00A
4 MF-890-FDM	4.8 (3/16")	R4361-F0F-F0B	B1409-890-FA0	R5301-F0F-1BD	R6001-F0S-40B-A	R6101-F0S-40B	B1623-850-00A
5 MF-890-GDM	5.6 (7/32")	R4361-F0G-F0B	B1409-890-GA0	R5301-F0G-1BD	R6001-F0S-40B-A	R6101-F0S-40B	B1623-850-00A
6 MF-890-HDM	6.4 (1/4")	R4361-F0H-F0B	B1409-890-HA0	R5301-F0H-1BD	R6001-F0H-40B-A	R6101-F0H-40B	B1623-850-00A
7 MF-890-FEM	4.8 (3/16")	R4361-F0F-H0E	B1409-890-FA0	R5302-F0F-1BE	R6001-F0S-30E	R6101-F0S-10E	B1623-850-00U
8 MF-890-GEM	5.6 (7/32")	R4361-F0G-H0E	B1409-890-GA0	R5302-F0G-1BE	R6001-F0S-30E	R6101-F0S-10E	B1623-850-00U
9 MF-890-HEM	6.4 (1/4")	R4361-F0H-H0E	B1409-890-HA0	R5302-F0H-1BE	R6001-F0H-30E	R6101-F0H-10E	B1623-850-00U

NUMERICAL INDEX OF PARTS

索引

Part No. 品番	Page 頁	Ref. No.	Part No. 品番	Page 頁	Ref. No.	Part No. 品番	Page 頁	Ref. No.	Part No. 品番	Page 頁	Ref. No.
OIL TUBE											
BP-3000000-0R	16	32	B1201-860-000-A	8	39	B1409-870-HA0	28	6-B	B1603-850-000	9	36
BP-5000000-00	14	49	B1201-880-000-A	8	38	B1409-870-HA0	28	9-B	B1604-850-000	9	30
BP-8000000-00	20	25	B1202-850-0A0	8	24	B1409-880-DA0	23	1-B	B1605-850-000-A	9	26
BT-0500300-E0	16	32	B1203-850-000	8	25	B1409-880-DA0	23	6-B	B1606-850-000-A	9	33
			B1204-850-0A0	8	32	B1409-880-DA0	23	11-B	B1607-850-0A0	9	18
			B1206-860-0A0	8	13	B1409-880-DA0	27	1-B	B1607-850-0A0-A	9	18
EXCLUSIVE PARTS "B" 専用部品 "B"			B1206-860-0B0	8	14	B1409-880-DA0	27	6-B	B1608-850-0A0	10	1
B1104-850-000-A	4	54	B1206-880-0A0	8	1	B1409-880-DA0	27	11-B	B1611-850-0A0-A	10	5
B1105-850-000-A	4	55	B1206-880-0B0	8	2	B1409-880-EA0	6	52	B1611-850-000	10	6
B1106-850-000-B	2	1	B1207-880-000	8	6	B1409-880-EA0	23	2-B	B1612-850-0AA	10	13
B1107-850-000-A	2	2	B1208-880-000	8	11	B1409-880-EA0	23	7-B	B1615-850-000	9	41
B1108-850-000	2	54	B1213-552-0A0	8	40	B1409-880-EA0	23	12-B	B1616-850-000	9	43
B1110-860-000	4	28	B1213-552-0A0-A	8	40	B1409-880-EA0	27	2-B	B1617-850-000	9	40
B1110-880-000	4	29	B1214-038-000	16	24	B1409-880-EA0	27	7-B	B1619-850-000	9	39
B1111-372-000	2	66	B1217-850-000	8	36	B1409-880-EA0	27	12-B	B1620-850-000-A	9	4
B1111-880-000	4	30	B1219-850-0A0	8	29	B1409-880-E00	6	53	B1621-850-000	9	8
B1112-850-000-A	2	35	B1224-552-000	8	42	B1409-880-FA0	23	3-B	B1622-850-000-A	9	9
B1113-850-000	2	36	B1226-552-000	8	41	B1409-880-FA0	23	8-B	B1623-850-00A	9	13
B1114-850-0A0	2	41	B1301-850-000	8	43	B1409-880-FA0	23	13-B	B1623-850-00A	26	1-F
B1115-850-000	2	37	B1302-850-0A0	8	31	B1409-880-FA0	27	3-B	B1623-850-00A	26	2-F
B1116-850-0AB	2	61	B1302-850-000	8	34	B1409-880-FA0	27	8-B	B1623-850-00A	26	3-F
B1116-850-000-B	2	62	B1303-850-0A0	8	59	B1409-880-FA0	27	13-B	B1623-850-00A	26	4-F
B1117-850-000	20	15	B1303-850-000	8	63	B1409-880-GA0	23	4-B	B1623-850-00A	26	5-F
B1118-850-000	2	68	B1304-850-000	8	62	B1409-880-GA0	23	9-B	B1623-850-00A	26	6-F
B1119-850-000	2	71	B1401-860-000-A	6	11	B1409-880-GA0	23	14-B	B1623-850-00A	26	7-F
B1120-372-000	2	60	B1402-850-000-A	6	16	B1409-880-GA0	27	4-B	B1623-850-00A	26	8-F
B1120-850-000	2	70	B1403-850-000	6	9	B1409-880-GA0	27	9-B	B1623-850-00A	26	9-F
B1122-850-000	2	66	B1405-850-0B0-A	6	17	B1409-880-GA0	27	14-B	B1623-850-00A	26	10-F
B1123-850-000	2	49	B1408-850-000	8	9	B1409-880-HA0	23	5-B	B1623-850-00A	27	1-F
B1124-850-000	2	53	B1408-850-000	8	19	B1409-880-HA0	23	10-B	B1623-850-00A	27	2-F
B1125-850-000	2	25	B1409-860-DA0	22	1-B	B1409-880-HA0	23	15-B	B1623-850-00A	27	3-F
B1128-850-000	2	33	B1409-860-DA0	22	6-B	B1409-880-HA0	27	5-B	B1623-850-00A	27	4-F
B1128-850-000	4	32	B1409-860-DA0	26	11-B	B1409-880-HA0	27	10-B	B1623-850-00A	27	5-F
B1129-850-000	2	31	B1409-860-DA0	26	1-B	B1409-880-HA0	27	15-B	B1623-850-00A	27	6-F
B1131-521-000	6	6	B1409-860-DA0	26	6-B	B1409-890-FA0	24	1-B	B1623-850-00A	27	7-F
B1131-850-000-C	2	22	B1409-860-DA0	26	11-B	B1409-890-FA0	24	4-B	B1623-850-00A	27	8-F
B1136-850-000	6	7	B1409-860-EA0	6	42	B1409-890-FA0	24	7-B	B1623-850-00A	27	9-F
B1137-850-000	2	15	B1409-860-EA0	22	2-B	B1409-890-FA0	28	1-B	B1623-850-00A	27	10-F
B1138-850-000	2	27	B1409-860-EA0	22	7-B	B1409-890-FA0	28	4-B	B1623-850-00A	28	1-F
B1139-019-000	2	52	B1409-860-EA0	22	12-B	B1409-890-FA0	28	7-B	B1623-850-00A	28	2-F
B1139-850-A00	25	2	B1409-860-EA0	26	2-B	B1409-890-GA0	6	59	B1623-850-00A	28	3-F
B1139-850-000	2	30	B1409-860-EA0	26	7-B	B1409-890-GA0	24	2-B	B1623-850-00A	28	4-F
B1140-352-000	2	20	B1409-860-EA0	26	12-B	B1409-890-GA0	24	5-B	B1623-850-00A	28	5-F
B1143-850-000	2	5	B1409-860-E00	6	43	B1409-890-GA0	24	8-B	B1623-850-00A	28	6-F
B1144-850-0A0	19	9	B1409-860-FA0	22	3-B	B1409-890-GA0	28	2-B	B1623-850-00A	28	1-F
B1144-850-000	19	10	B1409-860-FA0	22	8-B	B1409-890-GA0	28	5-B	B1623-850-00A	28	2-F
B1145-850-000	19	12	B1409-860-FA0	22	13-B	B1409-890-GA0	28	8-B	B1623-850-00A	28	3-F
B1146-850-000	19	17	B1409-860-FA0	26	3-B	B1409-890-G00	6	60	B1623-850-00A	28	4-F
B1147-850-000	19	14	B1409-860-FA0	26	8-B	B1409-890-HA0	24	3-B	B1623-850-00A	28	5-F
B1148-850-000	19	18	B1409-860-FA0	26	13-B	B1409-890-HA0	24	6-B	B1623-850-00A	28	6-F
B1150-850-000-A	4	59	B1409-860-GA0	22	4-B	B1409-890-HA0	24	9-B	B1623-850-00E	20	12
B1151-850-000-A	4	62	B1409-860-GA0	22	9-B	B1409-890-HA0	28	3-B	B1623-850-00U	26	11-F
B1152-850-000	4	63	B1409-860-GA0	22	14-B	B1409-890-HA0	28	6-B	B1623-850-00U	26	12-F
B1153-850-000	2	29	B1409-860-GA0	26	4-B	B1409-890-HA0	28	9-B	B1623-850-00U	26	13-F
B1154-850-000	2	50	B1409-860-GA0	26	9-B	B1410-860-F00	6	45	B1623-850-00U	26	14-F
B1155-850-000	2	16	B1409-860-GA0	26	14-B	B1410-860-F00	6	55	B1623-850-00U	26	15-F
B1156-850-000	2	4	B1409-860-HA0	27	5-B	B1410-860-H00	6	50	B1623-850-00U	27	11-F
B1158-850-000	4	51	B1409-860-HA0	27	10-B	B1410-860-H00	6	62	B1623-850-00U	27	12-F
B1159-850-000	4	52	B1409-860-HA0	27	15-B	B1411-481-0B0	6	12	B1623-850-00U	27	13-F
B1161-850-000	12	25	B1409-860-HA0	26	5-B	B1412-850-0A0	6	3	B1623-850-00U	27	14-F
B1162-850-000	2	43	B1409-860-HA0	26	10-B	B1412-850-0B0	6	2	B1623-850-00U	27	15-F
B1163-850-0A0	2	44	B1409-860-HA0	26	15-B	B1413-850-000	6	5	B1623-850-00U	28	7-F
B1163-850-000	2	45	B1409-870-FA0	24	1-B	B1414-226-000	8	21	B1623-850-00U	28	8-F
B1165-415-000	2	17	B1409-870-FA0	24	4-B	B1415-850-000	8	22	B1623-850-00U	28	9-F
B1166-122-000	12	6	B1409-870-FA0	24	7-B	B1501-850-000	4	12	B1623-850-00U	28	7-F
B1170-850-000	4	60	B1409-870-FA0	28	1-B	B1503-850-000	4	10	B1623-850-00U	28	8-F
B1173-850-000	4	58	B1409-870-FA0	28	4-B	B1505-227-000-A	4	24	B1623-850-00U	28	9-F
B1173-850-000	16	71	B1409-870-FA0	28	7-B	B1505-850-0A0	4	14	B1624-850-000	10	7
B1175-850-000	25	7	B1409-870-GA0	6	47	B1506-850-000	4	17	B1625-850-000	10	23
B1176-850-000	2	12	B1409-870-GA0	24	2-B	B1507-850-000	4	21	B1626-850-000	9	44
B1177-850-000	2	13	B1409-870-GA0	24	5-B	B1508-850-000	4	23	B1627-850-000-A	10	12
B1178-850-000	2	6	B1409-870-GA0	24	8-B	B1509-227-000	4	27	B1630-850-000	10	3
B1179-850-000	2	8	B1409-870-GA0	28	2-B	B1510-227-000	4	25	B1631-850-000	10	4
B1180-850-000	2	9	B1409-870-GA0	28	5-B	B1511-555-000	4	26	B1632-850-000	9	34
B1181-850-000	2	18	B1409-870-GA0	28	8-B	B1511-850-000	4	13	B1633-850-000	10	2
B1182-850-000	6	20	B1409-870-G00	6	48	B1523-226-000	4	19	B1633-850-000	12	28
B1183-850-000	18	63	B1409-870-HA0	24	3-B	B1601-850-0A0	9	20	B1702-850-0A0-A	10	20
B1185-850-000	4	59-1	B1409-870-HA0	24	6-B	B1602-850-0A0	9	1	B1703-850-B00	10	22
B1189-038-000	18	51	B1409-870-HA0	28	9-B	B1602-850-000	9	2	B1704-850-000-A	10	24
			B1409-870-HA0	28	3-B	B1603-850-0A0	9	35	B1704-850-000-B	10	24
B1121-890-000	2	73									



NUMERICAL INDEX OF PARTS

Part No. 品番	Page 頁	Ref. No.	Part No. 品番	Page 頁	Ref. No.	Part No. 品番	Page 頁	Ref. No.	Part No. 品番	Page 頁	Ref. No.
B1801-860-080-B	12	1	B2553-850-0A0	14	35	B3510-850-000	16	46	B8219-125-000	16	57
B1802-850-0A0	10	16	B2554-850-0A0-B	14	6	B3511-122-000	16	59	B9101-860-800	19	20
B1803-850-000	8	46	B2555-860-000-A	14	8	B3511-850-000	16	52	B9101-860-E00	19	21
B1804-850-000	8	51	B2558-860-000	14	37	B3512-122-000	16	60	B9203-850-000	14	53
B1804-850-000-A	8	51-1	B2559-860-0A0	14	38	B3512-850-000-B	16	42	B9204-850-0A0	14	48
B1805-850-0A0	8	60	B3102-850-0A0	11	23	B3513-804-000	16	63	B9205-850-000	14	44
B1806-850-A00	25	1	B3103-850-000	11	26	B3513-850-000-A	16	44	B9206-850-000	14	42
B1806-850-000	8	65	B3104-850-0A0	11	24	B3514-850-000	16	40	B9207-850-000	14	45
B1807-850-0A0	8	47	B3105-850-000	11	4	B3515-850-0A0	16	5	B9208-850-0A0	14	51
B1807-850-000-A	8	48	B3105-870-0AA	11	20	B3515-850-000	16	6	B9208-850-080	14	41
B1809-850-000-A	8	49	B3105-870-0A0	11	7	B3515-880-0A0-A	16	1	B9211-850-0A0	19	1
B1810-850-000	25	6	B3105-870-080	11	1	B3515-880-000-A	16	2	B9211-850-000	19	2
B1811-850-000	25	4	B3106-850-000	11	2	B3516-850-000	16	9	B9212-850-000	19	6
B1812-850-800	10	19	B3107-704-000	4	36	B3516-880-000	16	7	B9213-850-000	19	3
B1813-850-000	10	17	B3107-804-000	11	16	B3519-850-000	16	11	B9214-850-000	19	5
B1814-850-000	10	18	B3107-850-000	11	3	B3521-850-000	16	50	B9220-850-0A0	14	54
B1815-850-0A0	8	44	B3108-850-000	11	11	B3522-850-000	16	48	B9220-850-080	14	41
B1816-850-0A0	8	57	B3109-850-000	11	12	B3530-555-000	2	18	B9222-850-000	14	55
B1901-850-0A0	6	37	B3110-850-000	11	9	B3534-155-000	16	25	OIL WICK		油心
B1902-850-000	6	36	B3111-850-000	11	10	B3534-850-000	16	4	CQ-2020000-00	18	12
B1903-552-000	8	8	B3112-850-000	11	21	B3536-850-000	16	35	CQ-2020000-00	18	27
B1903-552-000	8	18	B3115-850-000	11	8	B3540-850-000-A	2	63	CQ-3000000-F0	14	3
B1903-850-000	6	35	B3119-771-000	4	39	B3541-850-0A0	8	55	CQ-3000000-F0	14	21
B1904-850-0A0	6	30	B3119-771-000	11	19	B3542-850-000-A	16	22	CQ-3000000-F0	16	15
B1905-541-800	8	10	B3120-125-000	4	38	B3544-850-000	16	33	CQ-3000000-F0	16	39
B1905-541-800	8	20	B3120-125-000	11	18	B3549-850-000	2	64	CQ-3000000-F0	16	49
B1905-850-000	6	32	B3126-012-000	4	35	B3550-850-000	16	54	CQ-3000000-F0	16	51
B1906-850-000	6	26	B3126-012-000	11	15	B3555-850-000	16	14	CQ-3000000-F0	18	18
B1907-850-000	6	33	B3129-012-A00	11	17	B3556-850-000	16	68	CQ-3030000-00	9	23
B1908-850-000	6	40	B3148-123-000	2	46	B3557-850-000	16	69	CQ-3030000-00	10	27
B1909-850-000	6	39	B3149-123-800	2	47	B3558-850-000	16	73	CQ-3030000-00	14	34
B1910-850-000	6	23	B3150-880-0A0	4	44	B3559-850-000	16	74	CQ-3030000-00	14	50
B1911-850-000	6	22	B3168-555-H08	4	48	B3560-850-000	16	72	CQ-4000000-F0	6	15
B1912-850-000	6	25	B3214-047-000	4	47	B3561-850-000	16	75	CQ-4000000-F0	12	2
B2015-357-000	18	15	B3216-047-000	4	49	B3563-850-000	16	78	CQ-4000000-F0	12	8
B2017-372-000	4	37	B3219-232-000	4	46	B3568-771-000	16	3	CQ-4000000-F0	14	13
B2017-372-000	11	22	B3301-704-0A0	21	1	B3901-880-A00	18	1	CQ-4000000-F0	14	50
B2201-860-0A0	10	30	B3301-704-000	21	27	B3901-880-000	18	2	THRUST COLLAR		スラストカラー
B2204-850-0A0-A	10	33	B3301-704-000-A	21	27	B3902-880-000	18	4	CS-0640860-SH	18	49
B2204-850-000-A	10	34	B3302-704-000	21	28	B3903-880-0A0	18	11	CS-070081A-SH	6	28
B2205-850-000	10	35	B3303-704-000	21	22	B3904-880-000-A	18	10	CS-079061C-TH	9	31
B2207-850-000	10	40	B3304-704-000	21	9	B3906-880-000-A	18	7	CS-103081A-TH	9	28
B2208-850-000	10	37	B3304-704-000-A	21	9-1	B3908-880-0A0	18	33	CS-1201010-SH	12	12
B2209-850-000	10	38	B3305-704-0A0	21	16	B3909-880-800	18	34	EXCLUSIVE PARTS "M" 専用部品 "M"		
B2502-850-000	12	19	B3305-704-000-A	21	16-1	B3910-880-0A0	18	20	MAO-11532000	21	31
B2503-850-000	12	10	B3306-704-000	21	6	B3910-880-000	18	21	NEEDLE		針
B2504-850-0A0	12	7	B3307-704-000	21	7	B3911-880-0A0-A	18	16	MC-3800006-50	6	1
B2505-850-0A0	12	14	B3307-804-000	21	18	B3912-880-0A0	18	26	NUT		ナット
B2507-850-0A0-A	12	20	B3308-704-000	21	8	B3913-880-000-A	18	13	NH-6040000-SH	21	16-3
B2507-850-000-A	12	21	B3309-704-000	21	13	B3914-880-000	18	25	NH-6050000-SC	21	12-1
B2508-850-0A0-A	12	26	B3310-704-000	21	10	B3915-880-000	18	32	NH-6060003-SC	21	12
B2508-850-080	12	27	B3311-012-000	21	23	B3917-880-000	18	24	NH-6160511-SE	21	3
B2509-850-000	12	31	B3311-704-000	21	5	B3920-880-0A0	8	27	NS-2820850-SA	4	26
B2510-850-000	12	33	B3311-804-000	21	14	B3921-880-000	18	36	NS-6110310-SP	2	40
B2511-850-0A0	14	19	B3312-012-000	21	17	B3922-880-0A0	18	39	NS-6110310-SP	4	45
B2512-850-080	14	15	B3313-704-0A0	21	2	B3923-880-000	18	38	NS-6110310-SP	10	42
B2512-850-000	14	16	B3313-704-000	21	2	B3924-880-000-A	18	41	NS-6110310-SP	18	55
B2513-850-0A0	10	28	B3317-704-000	21	3	B3925-880-000	18	48	NS-6110420-SP	16	21
B2514-860-G00	14	14	B3401-850-0A0	18	52	B3926-880-0A0-A	18	44	NS-6120310-SN	21	21
B2515-850-000	14	23	B3403-850-0A0	18	58	B3927-880-C00	18	46	NS-6150310-SP	4	41
B2516-850-0A0-A	14	1	B3404-122-000	16	13	B3928-880-0A0	4	33	NS-6150310-SP	18	37
B2517-850-0A0	14	27	B3405-850-U00	18	57	B3928-880-000	4	34	NS-6150320-SP	25	3
B2518-850-000	14	30	B3406-850-000	18	56	B3929-880-000	4	40	NS-6240630-SN	4	69
B2519-850-0A0	12	29	B3407-850-000	18	61	B3932-880-0A0	4	42	NS-6240630-SP	11	14
B2519-850-0A0	18	28	B3416-552-000	18	64	B3932-880-000	4	43	NS-6660430-SP	12	24
B2520-850-000-A	14	5	B3417-552-000	18	62	B3933-880-000	6	56	NS-6660430-SP	14	22
B2521-850-000	14	31	B3418-850-000	18	60	B3933-880-000	6	63	NS-6740510-SP	20	27
B2522-850-0A0	14	10	B3431-581-000	4	22	B3935-880-000	18	9	PIN		ピン
B2523-850-000	10	25	B3501-850-0A0	16	61	B3936-880-000	18	43	PS-0150082-KH	19	4
B2524-850-0A0	14	25	B3501-850-000	16	62	B4115-704-000	16	19	PS-0160162-KH	14	43
B2525-850-000-A	12	23	B3502-850-000	16	67	B5001-860-0A0	20	24	PS-0170082-KH	19	4
B2526-804-000	12	17	B3502-850-000-A	16	67-1	B5001-860-080	20	23	PS-0200142-K0	19	13
B2526-850-000	9	25	B3504-352-0A0	16	65	B5001-860-0C0	20	22	PS-0400182-K0	2	55
B2526-850-000	14	4	B3505-850-0A0	16	66	B5003-860-000	20	26			
B2527-850-8A0	9	22	B3506-761-000	16	37	B5004-860-000-A	20	16			
B2527-850-8A0	10	26	B3506-850-000	2	34	B5005-860-000	20	17			
B2527-850-8A0	14	33	B3507-850-000	16	30	B5006-860-000	20	19			
B2549-372-000	2	42	B3508-850-00A	16	27	B8202-850-000	4	64			
B2551-850-0A0	8	53	B3508-850-000-A	16	26	B8203-850-000	4	65			
B2552-850-000-A	14	32	B3509-850-000	16	29	B8205-850-000	4	67			



**ARTS Import Error:**

**Application error: LZW minimum code size other than 8 bit not supported in GIF file 'E:\www\images\PartsBook\juki\MF-860\0029.gif'**

NUMERICAL INDEX OF PARTS

索引

Part No. 品番	Page 頁	Ref. No.	Part No. 品番	Page 頁	Ref. No.	Part No. 品番	Page 頁	Ref. No.	Part No. 品番	Page 頁	Ref. No.
R6000-F0H-40B	24	3-E	R6100-F0G-40B	23	5-F	SCREW		ネジ	SS-7090910-SP	14	9
R6000-F0H-40B	24	6-E	R6100-F0G-40B	23	6-F				SS-7090910-SP	14	52
R6000-F0H-40E	22	15-E	R6100-F0G-40B	23	7-F	SK-3623200-SC	4	66	SS-7110410-SP	2	67
R6000-F0H-40E	23	15-E	R6100-F0G-40B	23	8-F	SM-6041410-SC	21	16-2	SS-7110410-SP	19	8
R6000-F0H-40E	24	9-E	R6100-F0G-40B	23	9-F	SM-6052700-SC	21	11-1	SS-7110510-SP	2	65
R6000-F0H-40E	24	9-E	R6100-F0G-40B	24	1-F	SM-9050813-SE	21	24	SS-7110510-SP	10	36
R6001-F0H-30E	26	15-D	R6100-F0G-40B	24	2-F	SM-9061080-SE	21	29	SS-7110510-SP	16	45
R6001-F0H-30E	27	15-D	R6100-F0G-40B	24	4-F	SM-9061203-SE	21	11	SS-7110510-SP	16	47
R6001-F0H-30E	28	9-D	R6100-F0G-40B	24	5-F	SQ-1110401-MZ	16	31	SS-7110510-SP	16	79
R6001-F0H-30E	28	9-D	R6100-F0G-40B	24	1-F	SS-2090550-TP	2	7	SS-7110510-SP	19	11
R6001-F0H-40B-A	26	5-D	R6100-F0G-40B	24	2-F	SS-2090620-SP	8	7	SS-7110510-SP	19	16
R6001-F0H-40B-A	26	10-D	R6100-F0G-40B	24	4-F	SS-2090620-SP	19	7	SS-7110510-SP	19	19
R6001-F0H-40B-A	27	5-D	R6100-F0G-40B	24	5-F	SS-2090710-SP	8	12	SS-7110540-SP	21	15
R6001-F0H-40B-A	27	10-D	R6100-F0H-10E	22	15-F	SS-2090820-TP	2	57	SS-7110630-TP	10	10-1
R6001-F0H-40B-A	28	3-D	R6100-F0H-10E	23	15-F	SS-2661310-TP	2	51	SS-7110710-SP	2	39
R6001-F0H-40B-A	28	6-D	R6100-F0H-10E	24	9-F	SS-4060310-SP	14	56	SS-7110710-SP	10	32
R6001-F0H-40B-A	28	3-D	R6100-F0H-10E	24	9-F	SS-5110710-SP	9	7	SS-7110710-SP	10	41
R6001-F0H-40B-A	28	6-D	R6100-F0H-40B	22	5-F	SS-5110710-SP	9	38	SS-7110740-TP	2	10
R6001-F0S-30E	26	11-D	R6100-F0H-40B	22	10-F	SS-5110810-SP	11	13	SS-7110740-TP	2	14
R6001-F0S-30E	26	12-D	R6100-F0H-40B	23	10-F	SS-5110810-SP	16	36	SS-7110740-TP	2	32
R6001-F0S-30E	26	13-D	R6100-F0H-40B	24	3-F	SS-6060210-SP	6	46	SS-7110740-TP	4	50
R6001-F0S-30E	26	14-D	R6100-F0H-40B	24	6-F	SS-6060210-SP	6	51	SS-7110740-TP	14	47
R6001-F0S-30E	27	11-D	R6100-F0H-40B	24	3-F	SS-6060210-SP	6	58	SS-7110740-TP	16	10
R6001-F0S-30E	27	12-D	R6100-F0H-40B	24	6-F	SS-6060210-SP	6	65	SS-7110740-TP	16	12
R6001-F0S-30E	27	13-D	R6101-F0H-10E	26	15-E	SS-6060410-TP	6	57	SS-7110740-TP	16	23
R6001-F0S-30E	27	14-D	R6101-F0H-10E	27	15-E	SS-6060410-TP	6	64	SS-7110740-TP	16	38
R6001-F0S-30E	28	7-D	R6101-F0H-10E	28	9-E	SS-6080410-SP	9	24	SS-7110740-TP	16	43
R6001-F0S-30E	28	8-D	R6101-F0H-10E	28	9-E	SS-6080720-SP	9	12	SS-7110740-TP	16	53
R6001-F0S-30E	28	7-D	R6101-F0H-40B	26	5-E	SS-6080810-SP	9	10	SS-7110740-TP	18	30
R6001-F0S-30E	28	8-D	R6101-F0H-40B	26	10-E	SS-6090440-SP	9	32	SS-7110810-SP	18	45
R6001-F0S-40B-A	26	1-D	R6101-F0H-40B	27	5-E	SS-6090510-SP	2	23	SS-7110840-SP	2	24
R6001-F0S-40B-A	26	2-D	R6101-F0H-40B	27	10-E	SS-6090510-TP	6	4	SS-7110840-SP	2	26
R6001-F0S-40B-A	26	3-D	R6101-F0H-40B	28	3-E	SS-6090612-TP	9	17	SS-7110910-SP	9	37
R6001-F0S-40B-A	26	4-D	R6101-F0H-40B	28	6-E	SS-6090630-SP	16	38	SS-7110910-SP	12	30
R6001-F0S-40B-A	26	6-D	R6101-F0H-40B	28	3-E	SS-6090640-SP	10	15	SS-7110910-SP	16	55
R6001-F0S-40B-A	26	7-D	R6101-F0H-40B	28	6-E	SS-6090650-SP	4	61	SS-7110910-SP	18	29
R6001-F0S-40B-A	26	8-D	R6101-F0S-10E	26	11-E	SS-6090670-TP	4	2	SS-7110910-SP	20	20
R6001-F0S-40B-A	26	9-D	R6101-F0S-10E	26	12-E	SS-6090670-TP	4	4	SS-7110910-TP	12	18
R6001-F0S-40B-A	27	1-D	R6101-F0S-10E	26	13-E	SS-6090670-TP	4	6	SS-7110910-TP	16	70
R6001-F0S-40B-A	27	2-D	R6101-F0S-10E	26	14-E	SS-6090670-TP	6	13	SS-7110910-TP	18	23
R6001-F0S-40B-A	27	3-D	R6101-F0S-10E	27	11-E	SS-6090670-TP	6	18	SS-7111110-TP	12	34
R6001-F0S-40B-A	27	4-D	R6101-F0S-10E	27	12-E	SS-6090670-TP	20	2	SS-7111120-SP	2	28
R6001-F0S-40B-A	27	6-D	R6101-F0S-10E	27	13-E	SS-6090670-TP	20	4	SS-7111120-SP	2	38
R6001-F0S-40B-A	27	7-D	R6101-F0S-10E	27	14-E	SS-6090670-TP	20	6	SS-7111120-SP	2	72
R6001-F0S-40B-A	27	8-D	R6101-F0S-10E	28	7-E	SS-6090910-SP	9	42	SS-7111120-SP	4	31
R6001-F0S-40B-A	27	9-D	R6101-F0S-10E	28	8-E	SS-6110420-TP	9	6	SS-7111120-SP	4	53
R6001-F0S-40B-A	28	1-D	R6101-F0S-10E	28	7-E	SS-6110480-SP	18	47	SS-7111120-SP	18	40
R6001-F0S-40B-A	28	2-D	R6101-F0S-10E	28	8-E	SS-6110620-TP	6	29	SS-7111310-TP	4	15
R6001-F0S-40B-A	28	4-D	R6101-F0S-40B	26	1-E	SS-6110620-TP	8	30	SS-7111410-SP	2	3
R6001-F0S-40B-A	28	5-D	R6101-F0S-40B	26	2-E	SS-6110640-SP	12	32	SS-7111410-SP	8	23
R6001-F0S-40B-A	28	1-D	R6101-F0S-40B	26	3-E	SS-6110710-TP	6	24	SS-7111410-SP	11	5
R6001-F0S-40B-A	28	2-D	R6101-F0S-40B	26	4-E	SS-6111010-TP	6	31	SS-7111410-SP	20	18
R6001-F0S-40B-A	28	4-D	R6101-F0S-40B	26	6-E	SS-6111210-SP	8	50	SS-7111410-TP	18	22
R6001-F0S-40B-A	28	5-D	R6101-F0S-40B	26	7-E	SS-6121210-SP	11	25	SS-7112420-SP	18	54
R6100-F0G-10E	20	14	R6101-F0S-40B	26	8-E	SS-6151440-SP	4	56	SS-7120640-SP	20	21
R6100-F0G-10E	22	11-F	R6101-F0S-40B	26	9-E	SS-6151920-SP	16	58	SS-7150740-SP	16	34
R6100-F0G-10E	22	12-F	R6101-F0S-40B	27	1-E	SS-6151920-TP	4	57	SS-7150740-SP	20	28
R6100-F0G-10E	22	13-F	R6101-F0S-40B	27	2-E	SS-6620730-SP	14	17	SS-7151120-SP	14	36
R6100-F0G-10E	22	14-F	R6101-F0S-40B	27	3-E	SS-6621212-TP	9	14	SS-7151210-SP	2	56
R6100-F0G-10E	23	11-F	R6101-F0S-40B	27	4-E	SS-6621212-TP	12	16	SS-7151210-SP	25	5
R6100-F0G-10E	23	12-F	R6101-F0S-40B	27	6-E	SS-6621212-TP	12	22	SS-7681750-TP	8	4
R6100-F0G-10E	23	13-F	R6101-F0S-40B	27	7-E	SS-6621212-TP	14	7	SS-7681750-TP	8	16
R6100-F0G-10E	23	14-F	R6101-F0S-40B	27	8-E	SS-6621212-TP	14	26	SS-8080310-TP	6	44
R6100-F0G-10E	24	7-F	R6101-F0S-40B	27	9-E	SS-6621212-TP	14	28	SS-8080310-TP	6	49
R6100-F0G-10E	24	8-F	R6101-F0S-40B	28	1-E	SS-6661110-SP	9	19	SS-8080310-TP	6	54
R6100-F0G-10E	24	7-F	R6101-F0S-40B	28	2-E	SS-6661110-SP	18	53	SS-8080310-TP	6	61
R6100-F0G-10E	24	8-F	R6101-F0S-40B	28	4-E	SS-6741010-SP	16	56	SS-8090410-SP	2	69
R6100-F0G-40B	9	16	R6101-F0S-40B	28	5-E	SS-7060310-SP	10	39	SS-8110320-SP	9	5
R6100-F0G-40B	22	1-F	R6101-F0S-40B	28	1-E	SS-7080510-SP	18	3	SS-8110320-SP	18	50
R6100-F0G-40B	22	2-F	R6101-F0S-40B	28	2-E	SS-7080510-TP	18	3	SS-8110410-SP	16	64
R6100-F0G-40B	22	3-F	R6101-F0S-40B	28	4-E	SS-7090410-SP	19	15	SS-8110410-TP	9	29
R6100-F0G-40B	22	4-F	R6101-F0S-40B	28	5-E	SS-7090510-SP	14	29	SS-8110410-TP	10	31
R6100-F0G-40B	22	6-F				SS-7090520-SP	16	8	SS-8110410-TP	18	5
R6100-F0G-40B	22	7-F	HINGE SCREW	段ネジ		SS-7090530-SP	6	21	SS-8110750-SP	8	58
R6100-F0G-40B	22	8-F	SD-0380551-SL	2	48	SS-7090540-TP	10	10	SS-8110750-SP	14	24
R6100-F0G-40B	22	9-F	SD-0380551-SL	6	8	SS-7090620-TP	14	39	SS-8110750-SP	18	8
R6100-F0G-40B	23	1-F	SD-0450701-TP	12	15	SS-7090710-SP	14	40	SS-8110750-SP	18	42
R6100-F0G-40B	23	2-F	SD-0630272-SP	4	18	SS-7090710-SP	16	76	SS-8111251-SP	8	52
R6100-F0G-40B	23	3-F	SD-0630275-SP	4	16	SS-7090910-SP	2	11	SS-8150310-SP	4	11
R6100-F0G-40B	23	4-F	SD-0870602-SP	18	35	SS-7090910-SP	6	34	SS-8150710-SP	6	10
						SS-7090620-TP	6	4	SS-7110910-TP	6	31
									SS-7681410-TP	8	4
									SS-7681410-TP	8	16

NUMERICAL INDEX OF PARTS

Part No. 品番	Page 頁	Ref. No.	Part No. 品番	Page 頁	Ref. No.	Part No. 品番	Page 頁	Ref. No.	Part No. 品番	Page 頁	Ref. No.
SS-8150710-SP	8	26									
SS-8150710-SP	8	56									
SS-8150710-SP	9	27									
SS-8150710-SP	10	8									
SS-8151150-SP	10	11									
SS-8151230-SP	6	27									
SS-8151230-SP	8	52									
SS-8151230-SP	12	11									
SS-8151230-SP	16	28									
SS-8151230-SP	18	19									
SS-8620610-SP	9	3									
SS-8660330-SP	8	45									
SS-8660610-SP	8	35									
SS-8660610-SP	8	64									
SS-8660610-TP	8	28									
SS-8660610-TP	12	13									
SS-8660612-TP	8	54									
SS-8660612-TP	10	21									
SS-8660612-TP	10	29									
SS-8661030-SP	6	38									
SS-8661030-SP	6	41									
SS-8661030-SP	8	37									
SS-8661030-SP	8	66									
SS-8681650-TP	8	5									
SS-8681650-TP	8	17									
PLUG		止メ栓									
TA-0180401-M0	14	12									
TA-0180401-M0	14	18									
TA-0290301-M0	12	3									
TA-0290301-M0	14	20									
TA-0290601-M0	12	4									
TA-0370301-M0	10	14									
TA-0370301-M0	16	16									
TA-0370301-M0	18	17									
TA-0400301-M0	12	9									
TA-0400301-M0	14	11									
TA-0500601-M0	12	5									
TA-0500601-M0	14	2									
TA-0570301-M0	9	21									
TA-0750704-R0	2	16									
TA-0750704-R0	4	53-1									
TA-1250406-R0	2	4									
TA-1250406-R0	2	15									
TA-2050805-R0	12	6									
TA-2100904-R0	2	17									
TA-2101002-R0	12	25									
WASHER		座金									
WP-0360516-SD	6	14									
WP-0360516-SD	6	19									
WP-0371016-SD	10	9									
WP-0371026-SD	19	7-1									
WP-0450801-SD	16	77									
WP-0480856-SD	9	15									
WP-0482086-SD	10	9-1									
WP-0482086-SD	16	20									
WP-0501016-SD	14	46									
WP-0501016-SD	18	31									
WP-0520656-SA	21	26									
WP-0560860-SE	21	19									
WP-0612066-SP	16	18									
WP-1002036-SC	4	68									
WP-1702600-S0	21	4									
WS-0521010-KN	21	20									
WS-0521010-KN	21	25									
WS-1643202-KR	21	30									
WZ-0430200-KH	11	6									